



USER GUIDE

Trimble® R7 GNSS Receiver Trimble R5 GPS Receiver



Blank page: Inside cover

USER GUIDE

Trimble® R7 GNSS Receiver Trimble R5 GPS Receiver

Version 4.10
Revision A
September 2009



Corporate office

Trimble Navigation Limited
Engineering and Construction group
5475 Kellenburger Road
Dayton, Ohio 45424-1099
USA

800-538-7800 (toll free in USA)
+1-937-245-5600 Phone
+1-937-233-9004 Fax
www.trimble.com

Legal notices

© 2004-2009, Trimble Navigation Limited. Trimble, the Globe & Triangle logo, and TSC2 are trademarks of Trimble Navigation Limited, registered in the United States and in other countries. CMR+, Digital Fieldbook, Micro-Centered, Maxwell, SiteNet, Trimble Geomatics Office, Trimble Survey Controller, TRIMMARK, TSC2, Zephyr, and Zephyr Geodetic are trademarks of Trimble Navigation Limited. The Bluetooth word mark and logos are owned by the Bluetooth SIG, Inc. and any use of such marks by Trimble Navigation Limited is under license. Microsoft, Windows, and Windows Vista are either registered trademarks or trademarks of Microsoft Corporation in the United States and/or other countries. All other trademarks are the property of their respective owners.

These products are protected by one or more of the following patents: 4754465, 4847862, 5148179, 5187450, 5202694, 5311149, 5402450, 5493588, 5515057, 5519620, 5486834, 6061632, 6252863, 7432853, 7312747, 7260476, 5523761, 5621416, 5923287, 6031882, 6810324

Release notice

This is the September 2009 release (Revision A) of the *Trimble R7 GNSS and R5 GPS Receivers User Guide*. It applies to version 4.10 of the Trimble R7 GNSS and R5 GPS receiver.

Product Limited Warranty Information

For applicable product Limited Warranty information, please refer to the Limited Warranty Card included with this Trimble product, or consult your local Trimble authorized dealer.

Product Extended Limited Warranty Information

For applicable product Extended Limited Warranty information, please refer to the Limited Warranty Card included with this Trimble product, or consult your Trimble dealer.

Notices

Class B Statement – Notice to Users. This equipment has been tested and found to comply with the limits for a Class B digital device, pursuant to Part 15 of the FCC rules. These limits are designed to provide reasonable protection against harmful interference in a residential installation. This equipment generates, uses, and can radiate radio frequency energy and, if not installed and used in accordance with the instructions, may cause harmful interference to radio communication. However, there is no guarantee that interference will not occur in a particular installation. If this equipment does cause harmful interference to radio or television reception, which can be determined by turning the equipment off and on, the user is encouraged to try to correct the interference by one or more of the following measures:

- Reorient or relocate the receiving antenna.
- Increase the separation between the equipment and the receiver.
- Connect the equipment into an outlet on a circuit different from that to which the receiver is connected.
- Consult the dealer or an experienced radio/TV technician for help.

Changes and modifications not expressly approved by the manufacturer or registrant of this equipment can void your authority to operate this equipment under Federal Communications Commission rules.

Canada

This digital apparatus does not exceed the Class B limits for radio noise emissions from digital apparatus as set out in the radio interference regulations of the Canadian Department of Communications. This Category II radiocommunication device complies with Industry Canada Standard RSS-310.

Le présent appareil numérique n'émet pas de bruits radioélectriques dépassant les limites applicables aux appareils numériques de Classe B prescrites dans le règlement sur le brouillage radioélectrique édicté par le Ministère des Communications du Canada. Ce dispositif de radiocommunication de catégorie II respecte la norme CNR-310 d'Industrie Canada.

Europe

This product has been tested and found to comply with the requirements for a Class B device pursuant to European Council Directive 1999/5/EC on R&TTE, thereby satisfying the requirements for CE Marking and sale within the European Economic Area (EEA). These requirements are designed to provide reasonable protection against harmful interference when the equipment is operated in a residential or commercial environment, and to ensure that the equipment is safe



Australia and New Zealand

This product conforms with the regulatory requirements of the Australian Communications and Media Authority (ACMA) EMC framework, thus satisfying the requirements for C-Tick Marking and sale within Australia and New Zealand.



Taiwan – Battery Recycling Requirements

The product contains a removable Lithium-ion battery. Taiwanese regulations require that waste batteries are recycled.



廢電池請回收

Notice to Our European Union Customers

For product recycling instructions and more information, please go to www.trimble.com/ev.shtml.

Recycling in Europe: To recycle Trimble WEEE (Waste Electrical and Electronic Equipment, products that run on electrical power), Call +31 497 53 24 30, and ask for the "WEEE Associate". Or, mail a request for recycling instructions to: Trimble Europe BV
c/o Menlo Worldwide Logistics
Meerheide 45
5521 DZ Eersel, NL



FCC Declaration of Conformity

We, Trimble Navigation Limited,

935 Stewart Drive
PO Box 3642
Sunnyvale, CA 94088-3642
United States
+1-408-481-8000

declare under sole responsibility that the products:
Trimble R5 GPS receiver and Trimble R7 GNSS receiver
comply with Part 15 of FCC Rules.

Operation is subject to the following two conditions:
(1) this device may not cause harmful interference, and
(2) this device must accept any interference received, including interference that may cause undesired operation.

RTTE Compliance statements

| | |
|------------|-----------------------------------------------------------------------------------------------------------------------------------------------------------------------------------------------------------------------------------------|
| Czech | Trimble Navigation Limited tímto prohlašuje, že tento [Trimble R7 GNSS / Trimble R5 GPS] je ve shodě se základními požadavky a dalšími příslušnými ustanoveními směrnice 1999/5/ES. |
| Danish | Undertegnede Trimble Navigation Limited erklærer herved, at følgende udstyr [Trimble R7 GNSS / Trimble R5 GPS] overholder de væsentlige krav og øvrige relevante krav i direktiv 1999/5/EF. |
| Dutch | Hierbij verklaart Trimble Navigation Limited dat het toestel [Trimble R7 GNSS / Trimble R5 GPS] in overeenstemming is met de essentiële eisen en de andere relevante bepalingen van richtlijn 1999/5/EG. |
| English | Hereby, Trimble Navigation Limited, declares that this equipment [Trimble R7 GNSS / Trimble R5 GPS] is in compliance with the essential requirements and other relevant provisions of Directive 1999/5/EC. |
| Estonian | Käesolevaga kinnitab Trimble Navigation Limited seadme [Trimble R7 GNSS / Trimble R5 GPS] vastavust direktiivi 1999/5/EÜ põhinõuetele ja nimetatud direktiivist tulenevatele teistele asjakohastele sätetele. |
| German | Hiermit erklärt Trimble Navigation Limited, dass sich das Gerät [Trimble R7 GNSS / Trimble R5 GPS] in Übereinstimmung mit den grundlegenden Anforderungen und den übrigen einschlägigen Bestimmungen der Richtlinie 1999/5/EG befindet. |
| Greek | ΜΕ ΤΗΝ ΠΑΡΟΥΣΑ Trimble Navigation Limited ΔΗΛΩΝΕΙ ΟΤΙ [Trimble R7 GNSS / Trimble R5 GPS] ΣΥΜΜΟΡΦΩΝΕΤΑΙ ΠΡΟΣ ΤΙΣ ΟΥΣΙΩΔΕΙΣ ΑΠΑΙΤΗΣΕΙΣ ΚΑΙ ΤΙΣ ΛΟΙΠΕΣ ΣΧΕΤΙΚΕΣ ΔΙΑΤΑΞΕΙΣ ΤΗΣ ΟΔΗΓΙΑΣ 1999/5/EK. |
| Hungarian | Alulírott, Trimble Navigation Limited nyilatkozom, hogy a [Trimble R7 GNSS / Trimble R5 GPS] megfelel a vonatkozó alapvető követelményeknek és az 1999/5/EC irányelv egyéb előírásainak. |
| Finnish | Trimble Navigation Limited vakuuttaa täten että [Trimble R7 GNSS / Trimble R5 GPS] tyypinen laite on direktiivin 1999/5/EY oleellisten vaatimusten ja sitä koskevien direktiivin muiden ehtojen mukainen. |
| French | Par la présente Trimble Navigation Limited déclare que l'appareil [Trimble R7 GNSS / Trimble R5 GPS] est conforme aux exigences essentielles et aux autres dispositions pertinentes de la directive 1999/5/CE. |
| Icelandic | Hér með lýsir Trimble Navigation Limited yfir því að [Trimble R7 GNSS / Trimble R5 GPS] er í samræmi við grunnkröfur og aðrar kröfur, sem gerðar eru í tilskipun 1999/5/EC |
| Italian | Con la presente Trimble Navigation Limited dichiara che questo [Trimble R7 GNSS / Trimble R5 GPS] è conforme ai requisiti essenziali ed alle altre disposizioni pertinenti stabilite dalla direttiva 1999/5/CE. |
| Latvian | Ar šo Trimble Navigation Limited deklarē, ka [Trimble R7 GNSS / Trimble R5 GPS] atbilst Direktīvas 1999/5/EK būtiskajām prasībām un citiem ar to saistītajiem noteikumiem. |
| Lithuanian | Šiuo Trimble Navigation Limited deklaruoja, kad šis [Trimble R7 GNSS / Trimble R5 GPS] atitinka esminius reikalavimus ir kitas 1999/5/EB Direktyvos nuostatas. |
| Maltese | Hawnhekk, Trimble Navigation Limited, jiddikjara li dan [Trimble R7 GNSS / Trimble R5 GPS] jikkonforma mal-htigijiet essenzjali u ma provvedimenti oħrajn relevanti li hemm fid-Direttiva 1999/5/EC. |
| Norwegian | Trimble Navigation Limited erklærer herved at utstyret [Trimble R7 GNSS / Trimble R5 GPS] er i samsvar med de grunnleggende krav og øvrige relevante krav i direktiv 1999/5/EF. |
| Polish | Niniejszym Trimble Navigation Limited oświadcza, że [Trimble R7 GNSS / Trimble R5 GPS] jest zgodny z zasadniczymi wymogami oraz pozostałymi stosownymi postanowieniami Dyrektywy 1999/5/EC |
| Portuguese | Trimble Navigation Limited declara que este [Trimble R7 GNSS / Trimble R5 GPS] está conforme com os requisitos essenciais e outras disposições da Directiva 1999/5/CE. |
| Slovak | Trimble Navigation Limited týmto vyhlasuje, že [Trimble R7 GNSS / Trimble R5 GPS] spĺňa základné požiadavky a všetky príslušné ustanovenia Smernice 1999/5/ES. |
| Slovenian | Trimble Navigation Limited izjavlja, da je ta [Trimble R7 GNSS / Trimble R5 GPS] v skladu z bistvenimi zahtevami in ostalimi relevantnimi določili direktive 1999/5/ES. |
| Spanish | Por medio de la presente Trimble Navigation Limited declara que el [Trimble R7 GNSS / Trimble R5 GPS] cumple con los requisitos esenciales y cualesquiera otras disposiciones aplicables o exigibles de la Directiva 1999/5/CE. |
| Swedish | Härmed intygar Trimble Navigation Limited att denna [Trimble R7 GNSS / Trimble R5 GPS] står i överensstämmelse med de väsentliga egenskapskrav och övriga relevanta bestämmelser som framgår av direktiv 1999/5/EG. |



Safety Information

This manual describes the Trimble® R7 GNSS and R5 GPS receivers. Unless otherwise specified, “the receiver” or “the receivers” refers to both receivers in this User Guide.

Before you use your receiver, make sure that you have read and understood this publication, as well as all safety requirements.

Warnings and Cautions

An absence of specific alerts does not mean that there are no safety risks involved.

Always follow the instructions that accompany a Warning or Caution. The information they provide is intended to minimize the risk of personal injury and/or damage to the equipment. In particular, observe safety instructions that are presented in the following formats:



WARNING – A Warning alerts you to a likely risk of serious injury to your person and/or damage to the equipment. A warning identifies the nature of the risk and the extent of possible injury and/or damage. It also describes how to protect yourself and/or the equipment from this risk. Warnings that appear in the text are repeated at the front of the manual.



CAUTION – A Caution alerts you to a possible risk of damage to the equipment and/or loss of data. A Caution describes how to protect the equipment and/or data from this risk.

Exposure to radio frequency radiation

You must maintain a minimum separation distance of 20 cm (approximately 8 in.) between yourself and the radiating antenna of a low power radiating device to satisfy the RF Exposure requirements of the FCC. Therefore, ensure that the Trimble receiver is 20 cm or further from the human body.

For Bluetooth radio

The radiated output power of the internal Bluetooth® wireless radio in the Trimble R7 GNSS receiver, is far below the FCC radio frequency exposure limits. Nevertheless, the wireless radio shall be used in such a manner that the Trimble receiver is 20 cm or further from the human body. The internal wireless radio operates within guidelines found in radio frequency safety standards and recommendations, which reflect the consensus of the scientific community. Trimble therefore believes the internal wireless radio is safe for use by consumers. The level of energy emitted is far less than the electromagnetic energy emitted by wireless devices such as mobile phones. However,

the use of wireless radios may be restricted in some situations or environments, such as on aircraft. If you are unsure of restrictions, you are encouraged to ask for authorization before turning on the wireless radio.

Rechargeable Lithium-ion batteries

These receivers use a rechargeable Lithium-ion battery.



WARNING – Do not damage the rechargeable Lithium-ion battery. A damaged battery can cause an explosion or fire, and can result in personal injury and/or property damage.

To prevent injury or damage:

- Do not use or charge the battery if it appears to be damaged. Signs of damage include, but are not limited to, discoloration, warping, and leaking battery fluid.
 - Do not expose the battery to fire, high temperature, or direct sunlight.
 - Do not immerse the battery in water.
 - Do not use or store the battery inside a vehicle during hot weather.
 - Do not drop or puncture the battery.
 - Do not open the battery or short-circuit its contacts.
-



WARNING – Avoid contact with the rechargeable Lithium-ion battery if it appears to be leaking. Battery fluid is corrosive, and contact with it can result in personal injury and/or property damage.

To prevent injury or damage:

- If the battery leaks, avoid contact with the battery fluid.
 - If battery fluid gets into your eyes, immediately rinse your eyes with clean water and seek medical attention. Do not rub your eyes!
 - If battery fluid gets onto your skin or clothing, immediately use clean water to wash off the battery fluid.
-



WARNING – Charge and use the rechargeable Lithium-ion battery only in strict accordance with the instructions. Charging or using the battery in unauthorized equipment can cause an explosion or fire, and can result in personal injury and/or equipment damage.

To prevent injury or damage:

- Do not charge or use the battery if it appears to be damaged or leaking.
 - Charge the Lithium-ion battery only in a Trimble product that is specified to charge it. Be sure to follow all instructions that are provided with the battery charger.
 - Discontinue charging a battery that gives off extreme heat or a burning odor.
 - Use the battery only in Trimble equipment that is specified to use it.
 - Use the battery only for its intended use and according to the instructions in the product documentation.
-

Other alerts



WARNING – Operating or storing the receiver outside the specified temperature range can damage it. For more information, see Physical specifications, page 7-58.



WARNING – When there is no USB cable connected, or when using the receiver in a harsh environment, keep the USB door closed to keep moisture, dust, and dirt out of the ports. The temperature rating of the receiver applies only when all doors on the receiver are closed.



WARNING – If the card does not seat into the pins correctly, do **not** use force or you may damage the pins. Remove the card and carefully reinsert it.



CAUTION – Do not hold down the power button for more than 30 seconds. After 30 seconds, any application files stored in the receiver are deleted.



CAUTION – Upgrading the firmware deletes all application files on the receiver.

Contents

| | |
|-------------------------------------------------|-----------|
| Safety Information | 5 |
| Warnings and Cautions | 5 |
| Exposure to radio frequency radiation | 5 |
| For Bluetooth radio | 5 |
| Rechargeable Lithium-ion batteries | 6 |
| Other alerts | 7 |
| 1 Introduction | 13 |
| Related information | 14 |
| Technical assistance | 14 |
| Your comments | 14 |
| 2 Overview | 15 |
| Features | 16 |
| Use and Care | 16 |
| COCOM Limits | 17 |
| 3 Setting up the Receiver | 19 |
| Parts of the receiver | 20 |
| Front panel | 20 |
| Rear panel | 21 |
| Top panel | 22 |
| Bottom panel | 23 |
| Setup guidelines | 23 |
| Environmental conditions | 23 |
| Sources of electrical interference | 24 |
| General guidelines | 24 |
| Postprocessed setup | 24 |
| Pole-mounted setup | 26 |
| Mounting the Zephyr antenna | 26 |
| Mounting the receiver on the pole | 26 |
| Mounting the controller | 27 |
| Backpack setup | 28 |
| Other system components | 30 |
| Radios | 30 |
| Cellular modems | 32 |
| Antennas | 33 |
| CompactFlash cards | 34 |
| 4 General Operation | 35 |
| Front panel controls | 36 |
| Button functions | 36 |
| LED behavior | 37 |

| | |
|----------------------------------------------------------------------------------|-----------|
| Logging/memory LED | 37 |
| SV Tracking LED | 37 |
| Radio LED | 38 |
| Battery 1 LED and battery 2 LED | 38 |
| Starting and stopping the receiver | 38 |
| Logging data | 38 |
| Logging internally | 38 |
| Logging to a Trimble controller | 39 |
| Resetting to defaults | 40 |
| Formatting a CompactFlash card | 40 |
| Batteries and power | 40 |
| Battery charging and storage | 43 |
| Operating with the controller | 44 |
| Power output | 44 |
| Firmware | 44 |
| 5 Configuration | 45 |
| Configuring the receiver in real Time. | 46 |
| Configuring the receiver using application files | 46 |
| Application files | 46 |
| Special application files | 46 |
| Timed application files | 47 |
| Applying application files. | 49 |
| Storing application files. | 49 |
| Naming application files | 49 |
| 6 Transferring Data | 51 |
| Connecting to the office computer | 52 |
| Transferring data | 53 |
| Transferring files from a CompactFlash card. | 53 |
| Transferring files using Trimble Business Center | 53 |
| Transferring files for processing in Trimble Geomatics Office software | 54 |
| Deleting files in the receiver | 55 |
| Supported file types | 55 |
| 7 Specifications. | 57 |
| Physical specifications | 58 |
| Positioning specifications | 58 |
| Technical specifications | 59 |
| 8 Default Settings | 61 |
| Default settings | 62 |
| Resetting to factory defaults | 63 |
| Default behavior. | 63 |
| Power up settings | 63 |
| Logging after power loss | 64 |
| Disabling logging | 64 |

| | | |
|-----------|------------------------------------------------------------------------|-----------|
| | Application files | 64 |
| 9 | Cables and Connectors | 67 |
| | Port 1, 2, and 3 connectors | 68 |
| | Power/serial data cable | 69 |
| | Event marker/1PPS cable | 70 |
| | GPS antennas and cables | 71 |
| 10 | Event Marker Input and 1PPS Output | 73 |
| | Event marker input | 74 |
| | Enabling and configuring event marker input | 74 |
| | 1PPS output | 75 |
| | 1PPS pulse definition | 75 |
| | ASCII time tag definition | 75 |
| | Enabling and configuring 1PPS output in real time | 76 |
| A | NMEA-0183 Output | 77 |
| | NMEA-0183 Outputs | 78 |
| | Common Message Elements | 79 |
| | Message values | 79 |
| | NMEA Messages | 80 |
| B | RTCM Output | 89 |
| | Generated messages | 90 |
| | Message scheduling | 91 |
| C | Troubleshooting | 93 |
| | LED conditions | 94 |
| | Receiver issues | 95 |
| D | Software Utilities | 97 |
| | The GPS Configurator software | 98 |
| | Installing the GPS Configurator software | 98 |
| | Configuring the receiver using the GPS Configurator software | 98 |
| | The WinFlash utility | 98 |
| | Installing the WinFlash utility | 99 |
| | Upgrading firmware | 99 |
| | Adding frequencies for the 450 MHz internal radio | 100 |

Introduction

- [Related information](#)
- [Technical assistance](#)
- [Your comments](#)

Welcome to the *Trimble R7 GNSS and R5 GPS Receivers User Guide*. This manual describes how to install, set up, and use a Trimble® R7 GNSS receiver or an R5 GPS receiver.

Unless otherwise specified, “the receiver” or “the receivers” refers to both receivers in this User Guide.

Even if you have used other Global Positioning System (GPS) products before, Trimble recommends that you spend some time reading this manual to learn about the special features of your receiver.

If you are not familiar with GPS, visit our website for an interactive look at Trimble and GPS at www.trimble.com

Trimble assumes that you are familiar with the Windows® operating system and know how to use a mouse, select options from menus and dialogs, make selections from lists, and refer to online help.

Related information

An electronic copy of this manual is available in portable document format (PDF) on the receiver CD-ROM. Use Adobe Reader to view the contents of this file.

Other sources of related information are:

- Release notes – the release notes describe new features of the product, information not included in the manual, and any changes to the manual. They are provided as a PDF on the CD. Use Adobe Reader to view the contents of the release notes.
- Registration – register your receiver to automatically receive e-mail notifications of receiver firmware upgrades and new functionality. To register, do one of the following:
 - Run the receiver CD.
 - Register electronically at www.trimble.com.
 - Print the registration form that is on the CD, fill it in, and fax or mail it to the address shown.

Contact your local Trimble Dealer for more information about the support agreement contracts for software and firmware, and an extended warranty program for hardware.
- Trimble training courses – consider a training course to help you use your GPS system to its fullest potential. For more information, visit the Trimble website at www.trimble.com/training.html.

Technical assistance

If you have a problem and cannot find the information you need in the product documentation, *contact your local Dealer*. Alternatively, request technical support using the Trimble website at (www.trimble.com/support.html).

Your comments

Your feedback about the supporting documentation helps us to improve it with each revision. E-mail your comments to ReaderFeedback@trimble.com.

Overview

In this chapter:

- [Features](#)
- [Use and Care](#)
- [COCOM Limits](#)

This chapter introduces the Trimble® R7 GNSS receiver and the R5 GPS receiver for GNSS and GPS surveying applications.

Unless otherwise specified, “the receiver” or “the receivers” refers to all receivers covered in this User Guide.

The receiver features one-touch logging for ease of use, and five LEDs that enable you to monitor the survey in progress and the available battery capacity.

The receivers track GPS and GLONASS satellites on both L1 and L2 frequencies. They can record data on an internal CompactFlash card and make all data available through serial or USB ports.

You can use the receiver alone by logging data internally, or as part of a Trimble GPS/GNSS system, which logs GPS data from the receiver to Trimble controllers running Trimble Field software.

Features

The receiver provides the following features:

- Trimble R-track technology, which enables the receivers to track GLONASS (standard feature on the Trimble R7 GNSS receiver; optional upgrade on the Trimble R5 GPS receiver), L2C, and L5 (Trimble R7 GNSS receiver only)
- Centimeter-accuracy real-time positioning with RTK/OTF data, and up to 20 Hz position updates for the R7 GNSS or up to 10 Hz position updates for the R5 GPS receiver
- Submeter-accuracy real-time positioning using pseudorange corrections
- Adaptive dual-frequency RTK engine
- WAAS/EGNOS capability (Wide Area Augmentation System/European Geostationary Navigation System)
- Automatic OTF (on-the-fly) initialization while moving
- 1PPS (One Pulse Per Second) output
- Dual event-marker input
- USB port for data transfer
- Type I CompactFlash card for data storage
- Internal charging of batteries (no external battery charger required)
- Cable-free Bluetooth support for communication with Trimble controllers (Trimble R7 GNSS receiver only)
- Three RS-232 serial ports for:
 - NMEA output
 - RTCM SC-104 input and output
 - Trimble Format (CMR+™ and CMRx) input and output
- Two TNC ports for connecting to the GPS/GNSS and radio antennas

Use and Care

The receiver can withstand the rough treatment that typically occurs in the field. However, the receiver is a high-precision electronic instrument and should be treated with reasonable care.



WARNING – Operating or storing the receiver outside the specified temperature range can damage it. For more information, see [Physical specifications, page 58](#).

High-power signals from a nearby radio or radar transmitter can overwhelm the receiver circuits. This does not harm the instrument, but it can prevent the receiver electronics from functioning correctly. Avoid using the receiver within 400 meters of

powerful radar, television, or other transmitters. Low-power transmitters such as those used in cellphones and two-way radios normally do not interfere with receiver operations.

For more information, contact your local Trimble distributor.

COCOM Limits

The U.S. Department of Commerce requires that all exportable GPS products contain performance limitations so that they cannot be used in a manner that could threaten the security of the United States. The following limitations are implemented on the receiver.

Immediate access to GPS satellite measurements and navigation results is disabled when the receiver's velocity is computed to be greater than 1000 knots, or its altitude is computed to be above 18,000 meters. The receiver continuously resets until the COCOM situation is cleared.

Setting up the Receiver

In this chapter:

- [Parts of the receiver](#)
- [Setup guidelines](#)
- [Postprocessed setup](#)
- [Pole-mounted setup](#)
- [Backpack setup](#)
- [Other system components](#)

This chapter provides general information on setup, connection, and cabling for the most common uses of the receiver.

Parts of the receiver

All operating controls, ports, and connectors on the receiver are located on its four main panels, as shown below. This section provides a brief overview of the features of each of these panels.



Front panel

The receiver front panel is shown below. This panel contains the indicator LEDs, the two buttons, and the catch for the CompactFlash/USB door.

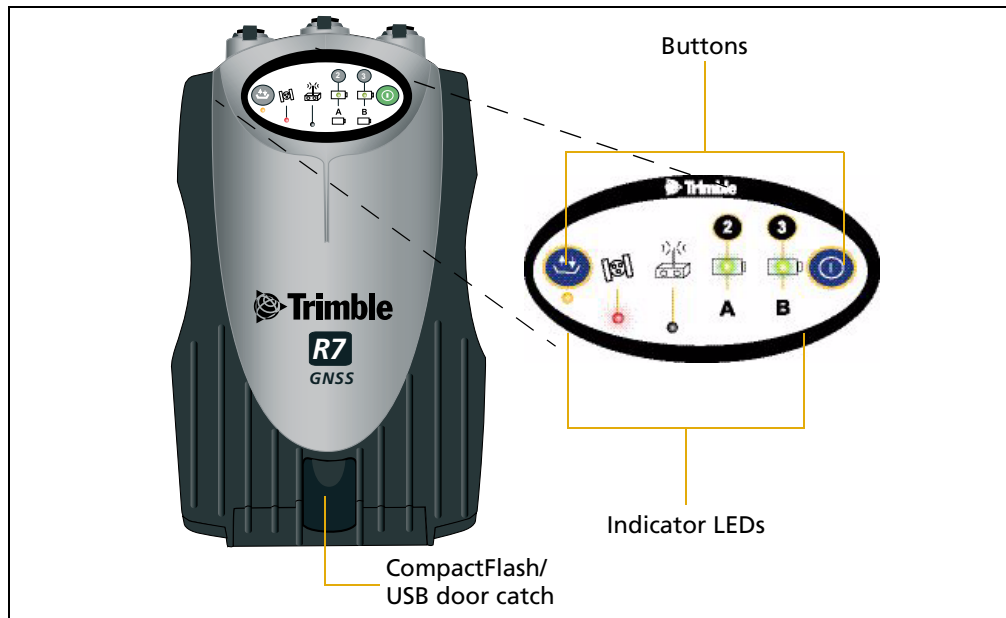

The two buttons control data logging, data management, power, and settings. For more information, see [Button functions, page 36](#).

The indicator LEDs show the status of logging, power, satellite tracking, and radio reception. For more information, see [LED behavior, page 37](#).

Rear panel

The receiver rear panel is shown below. This panel contains a slot for attaching the receiver catch lock, and the catches for the two battery compartments on the bottom panel. The catch lock should already be attached to your receiver.

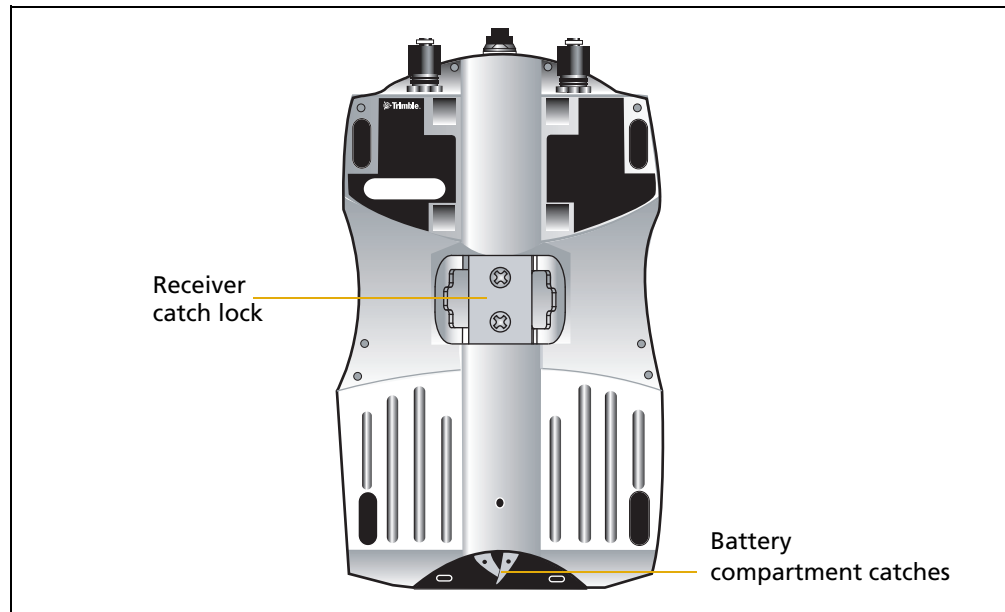



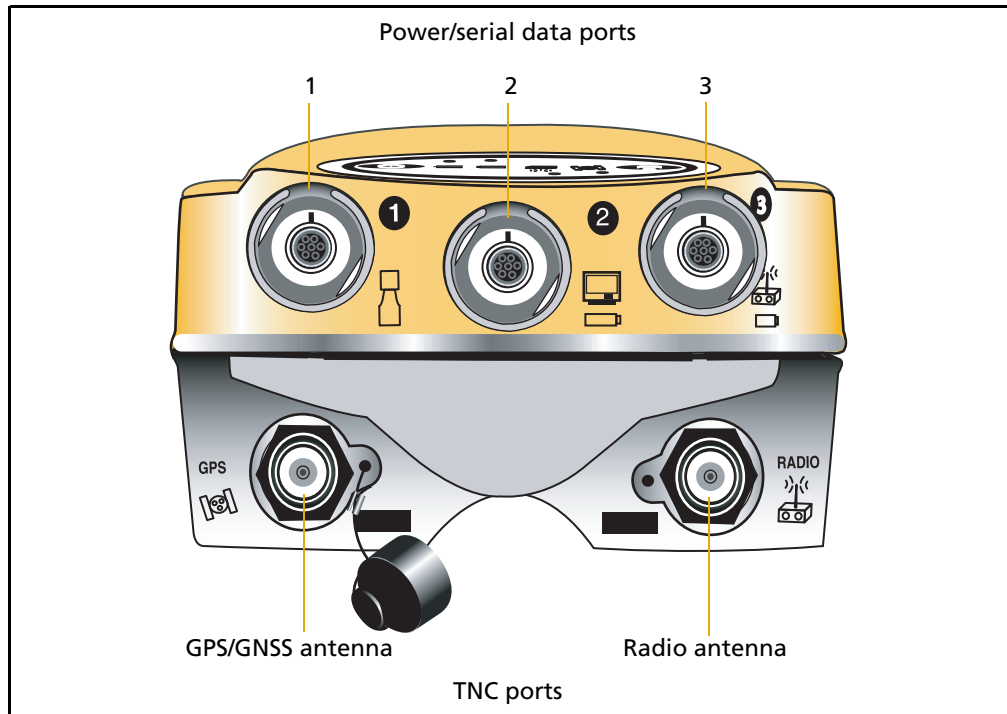

To mount the receiver on a pole, attach the receiver bracket to the pole and then insert the catch lock into the bracket. For more information, see [Pole-mounted setup, page 26](#).

Top panel

The receiver top panel is shown below. This panel contains the three power/serial data ports and (TNC) ports for GPS and radio antenna connections.



Each port on the top panel is marked with an icon to indicate its main function, as shown below.

| Icon | Name | Connections |
|-------------------------------------------------------------------------------------|--------|-----------------------------------------------|
|  | Port 1 | Trimble controller, event marker, or computer |
|  | Port 2 | Power in, computer, 1PPS, or event marker |
|  | Port 3 | External radio, power in |
|  | GPS | GPS/GNSS antenna |
|  | RADIO | Radio communications antenna |

The power/serial data ports are all 7 pin 0-shell Lemo connectors. Both Port 2 and Port 3 can accept external power. For more information, see [Default settings, page 62](#) and [Cables and Connectors, page 67](#).

Connect the GPS/GNSS antenna cable to the TNC port marked GPS, and connect the Quarter-wave whip antenna (rubber duck) to the TNC connector marked RADIO. For more information on connecting the receiver, see the following sections in this chapter.

Bottom panel

The receiver bottom panel is shown below. This panel contains the USB port, the CompactFlash port, and the compartments for the two internal batteries.

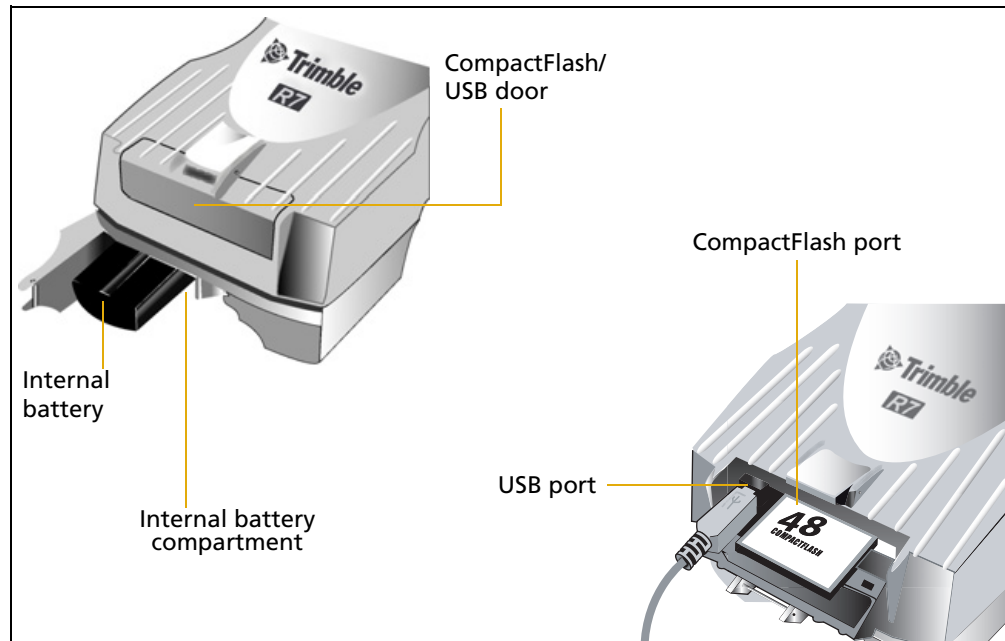

The CompactFlash/USB door conceals the CompactFlash port and USB port. To open the door, push down the catch on the front panel.



WARNING – When there is no USB cable connected, or when using the receiver in a harsh environment, keep this door closed to keep moisture, dust, and dirt out of the ports. The temperature rating of the receiver applies only when all doors on the receiver are closed.

Setup guidelines

When setting up the receiver, follow these guidelines.

Environmental conditions

Although the receiver has a waterproof housing, take reasonable care to keep the unit dry. Avoid exposure to extreme environmental conditions, including:

- Water
- Heat greater than 65° C (149° F)

- Cold less than -40°C (-40°F)
- Corrosive fluids and gases

Avoiding these conditions improves the receiver performance and long-term reliability.

Sources of electrical interference

Avoid the following sources of electrical and magnetic noise:

- Gasoline engines (spark plugs)
- Televisions and computer monitors
- Alternators and generators
- Electric motors
- Equipment with DC-to-AC converters
- Fluorescent lights
- Switching power supplies

General guidelines



WARNING – These receivers use a rechargeable Lithium-ion battery. To avoid personal injury or equipment damage, make sure that you read and understand the Safety Information on [page 5](#) at the front of this manual.

The following guidelines apply whenever you set up your receiver for operation:

- When plugging in a Lemo cable, make sure that the red dots on the receiver port and the cable connector line up. **Do not** use force to plug cables in, as this may damage the connector pins.
- When disconnecting a Lemo cable, grasp the cable by the sliding collar or lanyard and pull the cable connector straight out of the port. Do not twist the connector or pull on the cable itself.
- To securely connect a TNC cable, align the cable connector with the receiver receptacle and thread the cable connector onto the receptacle until snug.
- Insert the internal batteries with the battery contacts facing the CompactFlash/USB door. The undersides of the batteries have a center groove for alignment when being inserted into the receiver.

Postprocessed setup

For a postprocessed survey, you only need:

- the receiver

- one of the following antennas:
 - Zephyr™ or Zephyr Geodetic™
 - Zephyr 2 or Zephyr Geodetic 2
- a GPS/GNSS antenna cable

Other equipment, as described below, is optional.

To set up the receiver for a postprocessed survey:

1. Set up the tripod with the tribrach and antenna adapter over the survey mark.
Instead of a tripod, you can use a range pole with a bipod. However, Trimble recommends that you use a tripod for greater stability.
2. Mount the antenna on the tribrach adapter.
3. Use the tripod clip to hang the receiver on the tripod.
4. Connect the GPS/GNSS antenna cable to the Zephyr antenna.
5. Connect the other end of the GPS/GNSS antenna cable to the TNC port on the receiver.
6. If external power is required, connect a battery with an 0-shell Lemo connection to Port 2 or Port 3 on the receiver.

The following figure shows the receiver postprocessed setup.



Note – Instead of hanging the receiver on the tripod, you can place the receiver in its base case. Run the antenna cable out of the portal in the side of the base case to the antenna so that the case can stay closed while the receiver is running.

Pole-mounted setup

Do the following:

1. Mount the Zephyr antenna. See [page 26](#).
2. Mount the receiver on the pole. See [page 26](#).
3. Attach the controller. See [page 27](#).

Mounting the Zephyr antenna

1. Screw the antenna to the 5/8-11 threads on the top of the range pole.
2. Connect the TNC-to-TNC GPS cable to the port on the top of the receiver.
3. Connect the TNC-to-TNC GPS cable to the antenna.

Mounting the receiver on the pole

1. Attach the receiver bracket to the pole:
 - a. Place the bracket against the pole, approximately 0.5 m from the ground.

Note – If you are using a 1" diameter pole, flip the bracket insert around inside the bracket, as shown in [Figure 3.1](#).

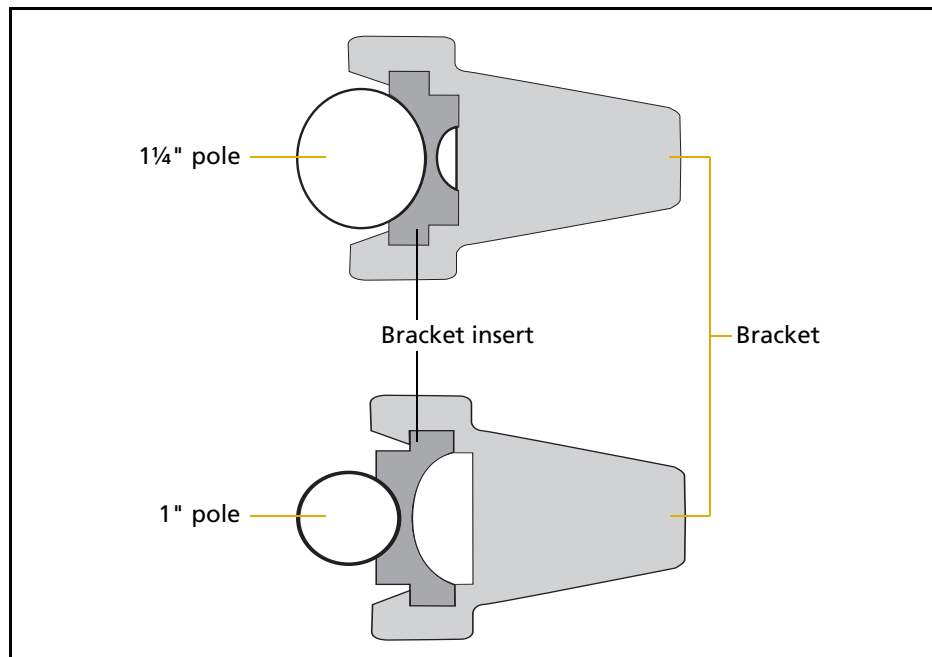

Figure 3.1 Receiver bracket insert

- b. Close the gates of the bracket around the pole.
- c. Seat the base of the clip lock in the opposite gate.

- d. Lock the clip lock.

If the clip lock is too tight to be locked, turn it one or two turns counterclockwise and try again. If it is too loose, turn it one or two turns clockwise and try to lock it again.

2. Mount the receiver on the bracket:
 - a. Pull the bracket side locks in towards the pole.
 - b. Set the receiver catch lock in the bracket.
 - c. Holding the receiver in the bracket, pull the side locks back to their original positions, as shown below.

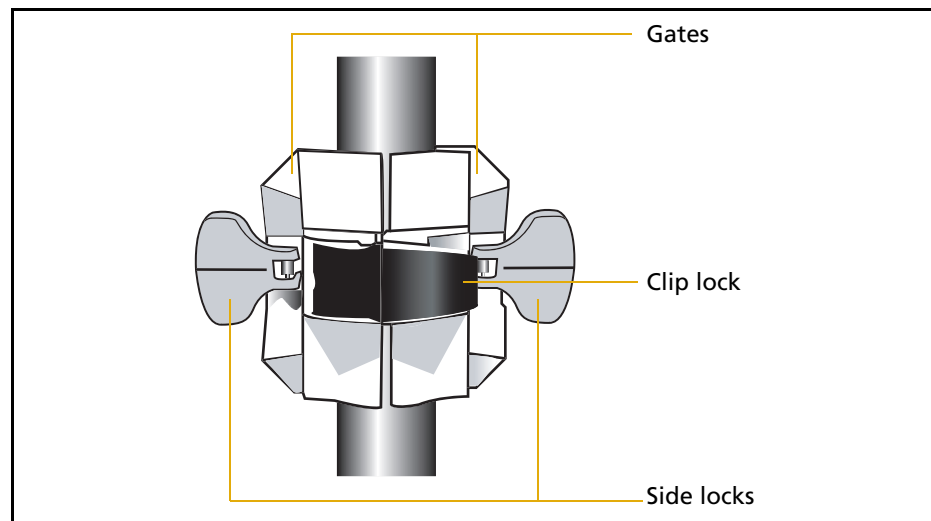

3. Connect the quarter-wave whip (“rubber duck”) antenna to the radio port on top of the receiver.
4. If necessary, adjust the position of the receiver to remove cable slack from the TNC GPS antenna cable.

Mounting the controller

1. Mount the TSC2[®] controller bracket on the pole:
 - a. Place the bracket against the pole at a comfortable height.
 - b. Rotate the pole clamping screw on the controller bracket until tight.
 - c. Place the controller into the cradle assembly and tighten the clamping mechanism.
 - d. If there are any cables running down the pole, run them through the machined groove on the inside of the controller bracket.
 - e. To put the controller in the preferred position for operation, press the spring-loaded release button on the cradle, pull the assembly outward, and then rotate the cradle assembly to the required angle. To rest the cradle in

the proper position, line up the alignment pin on the cradle with the hole in the controller bracket and then push it inward until the release button locks.

Note – If you use Bluetooth wireless technology with the Trimble R7 GNSS receiver, omit steps 2 and 3.

2. Connect the DB9-to-0-shell Lemo cable to the controller.
3. Connect the other end of the cable to Lemo Port 1 on the receiver.
4. Place the hand grip below the controller bracket (or above it, depending on the position of the bracket), with the cables running through the grip.
5. Secure any loose cables, using the velcro cable ties.

The following figure shows the completed pole-mounted setup.



Backpack setup

To set up the receiver for use in a backpack:

1. Insert the receiver into the backpack with the ports on the top panel facing upwards and the front panel facing outwards. Secure the receiver around the middle with the velcro strap.
2. Attach the Zephyr™ antenna to a range pole.

3. Attach the whip antenna mount to one of the fittings on the top of the backpack.
4. The backpack has a feedthrough on both sides at the top and on both sides near the bottom to allow cables to be positioned out of the way of the main zipper. Run the radio communications cable through at the top, and connect it to the blue TNC port on the receiver.
5. Connect the straight end of the yellow GPS cable to the yellow TNC port on the receiver.
6. Run the right-angle connector on the yellow GPS cable through the top or side slot on the backpack, and then connect it to the Zephyr antenna.
7. Connect the DB9-to-0-shell Lemo cable to Port 1 on the receiver.
8. Run the DB9 cable through the side slot of the backpack and then connect it to the controller.

Note – Trimble does not recommend using a Bluetooth connection for a backpack setup.

The following figure shows the backpack setup.

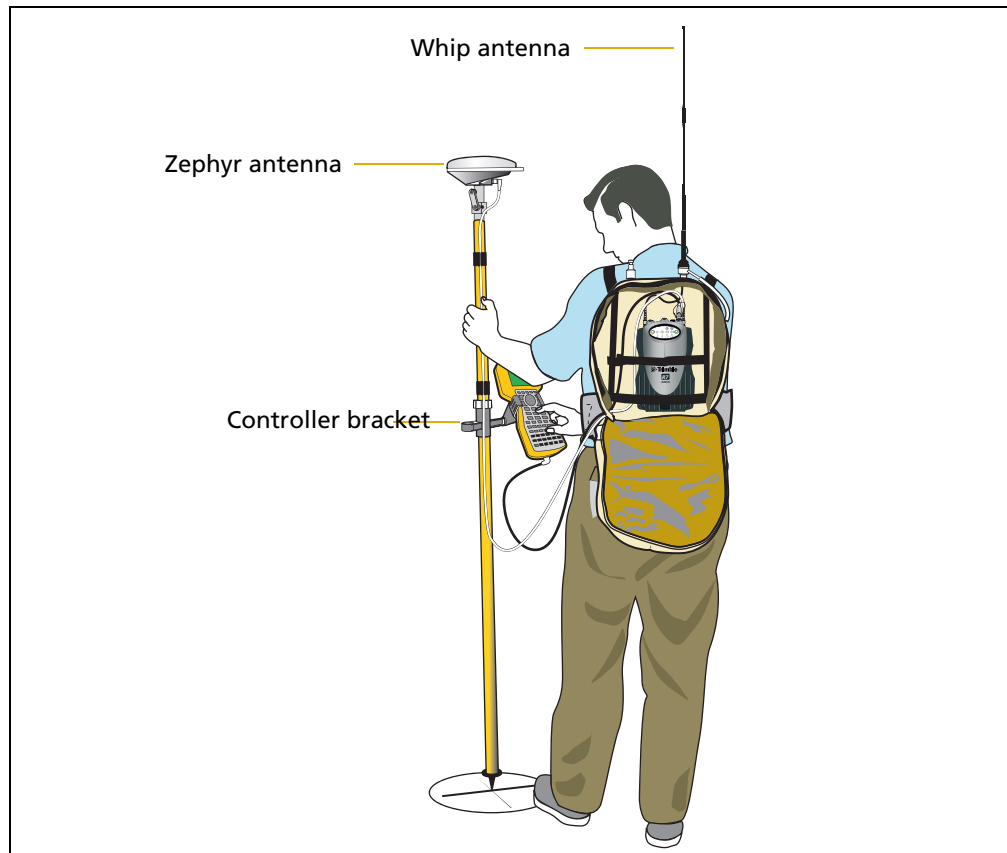

Other system components

This section describes optional components that you can use with the receiver.

Radios

Radios are the most common data link for Real-Time Kinematic (RTK) surveying. The receiver is available with an internal receive-only radio that uses a UHF frequency band in the 410 MHz to 470 MHz range. You can also connect an external radio to Port 3, whether or not the internal radio is installed.

The receiver supports the following Trimble base radios when using the internal receiver radio:

- Trimble HPB450
- Trimble PDL450
- Trimble TDL 450L
- Receiver internal 450 MHz transmitter

- TRIMMARK™ 3 radio
- SiteNet™ 450 radio

Internal radio setup

To configure the receiver optional internal radio, use one of the following:

- The GPS Configurator software
- The WinFlash utility
- The Trimble Survey Controller™ software
- The Trimble Digital Fieldbook™ software

For more information, refer to the documentation for these applications.

By default, the internal radio has only a few “test” frequencies installed at the factory. You can program the receive frequencies using the WinFlash utility. For more information, see [The WinFlash utility, page 98](#).

External radio setup

To use an external radio with the receiver, you need to set up an external power source for the radio:

1. Connect one end of the GPS antenna cable to the TNC port on the receiver.
2. Connect the other end of the GPS antenna cable to one of the following antennas:
 - Zephyr or Zephyr Geodetic
 - Zephyr 2 or Zephyr Geodetic 2
3. Connect the external radio to Port 3 on the receiver.
4. Connect a radio antenna to the external radio.
5. Connect an external power source to Port 2 on the receiver.

***Note** – External rover radios must have their own power source because the internal Lithium-ion batteries do not supply enough voltage. Alternatively, supply external power to Port 2 of the receiver, and enable power out on Port 3. Base (transmit/receive) radios must have their own power source because of their high power consumption.*

Alternatively, you can apply external power directly to the radio, if it supports it.

You can use a 10 Ah battery, a 6 Ah battery, or camcorder batteries. The choice of power supply depends on the application, and whether you are using the radio as a base or rover radio. For more information about the power capabilities of the receiver, see [Batteries and power, page 40](#).

6. Configure the external radio using Trimble Survey Controller software. Alternatively, you can configure an external radio using the WinFlash utility or the configuration software supplied with the radio.

For more information, refer to the *Trimble Survey Controller User Guide* or the appropriate Help.

7. Set up any other equipment as required, depending on whether you are using the radio as a reference or a rover radio.

Cellular modems

You can use a cellular modem instead of a radio as your data communications link. Cellular modems and other radio links can be used to extend the limits of your surveys.

To connect a cellular modem to a receiver, you need the following:

- A receiver
- A custom-designed cellular modem, or a cellphone that can transmit and receive data
- Serial (cellphone to DB9) cable (supplied with the cellular modem or phone)
- Trimble DB9 to 0-shell Lemo cable

Note – *This cable is suitable only if flow control can be disabled on the cellular modem. If the cellular modem does not support this functionality, a special cable is required. For more information, refer to the document *Using Cellular and CDPD Modems for RTK*, which is available from your local Trimble Reseller.*

The following figure shows the components required to connect a cellphone to a receiver.

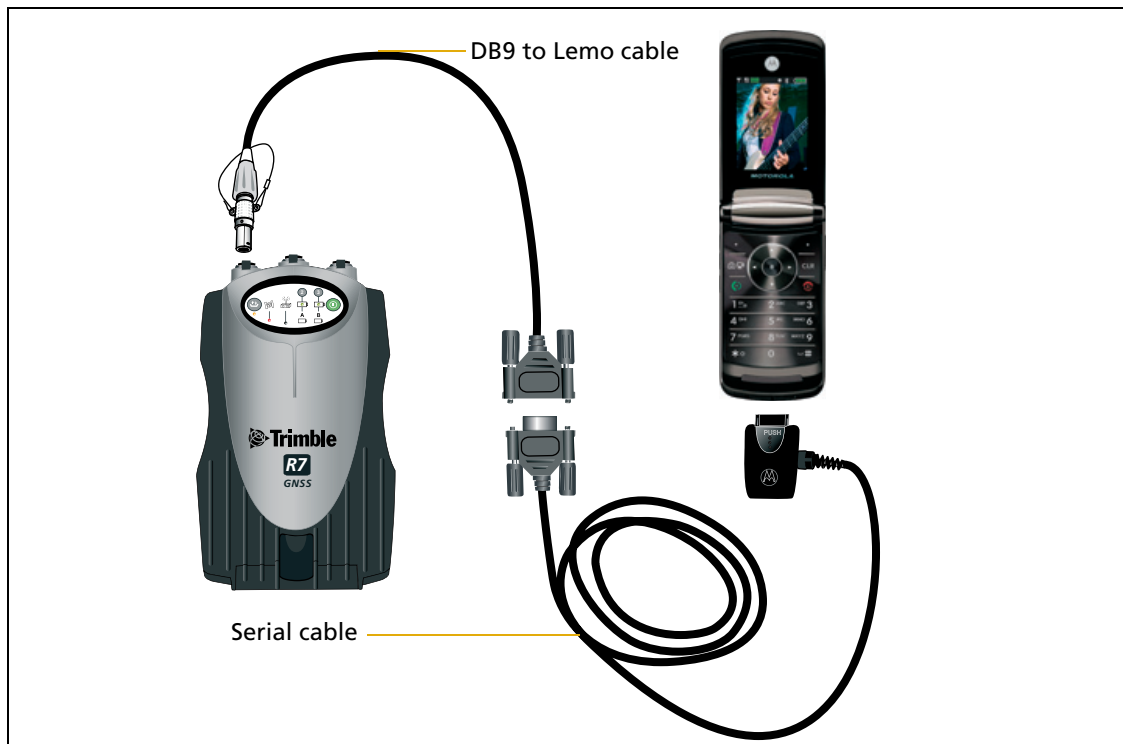

For more information on using a cellular modem as a data link, refer to the *Trimble Survey Controller User Guide*.

Antennas

The receiver should normally be used with one of the following antennas, which have been designed specifically for them:

- Zephyr or Zephyr Geodetic
- Zephyr 2 or Zephyr Geodetic 2

Use the following figure as a guide for measuring the height of the Zephyr and Zephyr Geodetic antennas. The Zephyr antenna is designed to be measured to the top of the notch. The Zephyr Geodetic (shown) has been designed to be measured to the bottom of the notch.

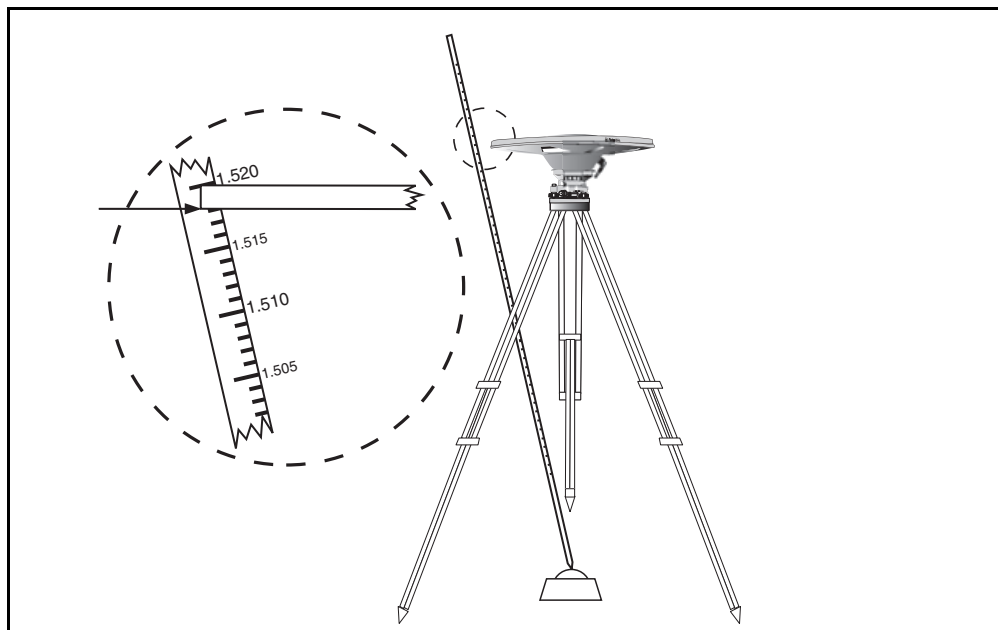

Some models of antennas, such as the Choke Ring or older Micro-Centered™ L1/L2 antennas, need more power to operate than the Zephyr models. To configure the receiver to output more power on the antenna port, select the correct antenna type in GPS Configurator, or through the Trimble controller. For information on how to do this, contact your local Trimble Service Provider.

CompactFlash cards

The receiver logs data internally on a CompactFlash card. However, it only supports the Type I CompactFlash card. Trimble recommends that you use an industrial-rated CompactFlash card, as commercial cards have a limited operating temperature range.

Before logging data to a CompactFlash card, format the card to ensure the integrity of the file system. To format the card, insert it in the receiver and then hold down the power button for 30 seconds.

***Note** – Make sure that you format your CompactFlash card in the receiver. This prevents data on the card from being corrupted if the card is removed while data is being logged. Formatting the card in your computer may cause data corruption, or loss of data.*

When inserting the card, make sure that it slides into the card slot properly.



CAUTION – The receiver allows for more than 500 files on the CompactFlash card, regardless of the card's capacity. The file names must be in 8.3 format, otherwise, files copied to the CompactFlash card may cause data corruption or loss of data when logging.



CAUTION – If the card does not seat into the pins correctly, do **not** use force or you may damage the pins. Remove the card and carefully reinsert it.

General Operation

In this chapter:

- Front panel controls
- Button functions
- LED behavior
- Starting and stopping the receiver
- Logging data
- Resetting to defaults
- Formatting a CompactFlash card
- Batteries and power

All the controls that you need for general receiver operation are on the front panel.

For more information about other receiver panels, see [Parts of the receiver](#), page 20.

Front panel controls

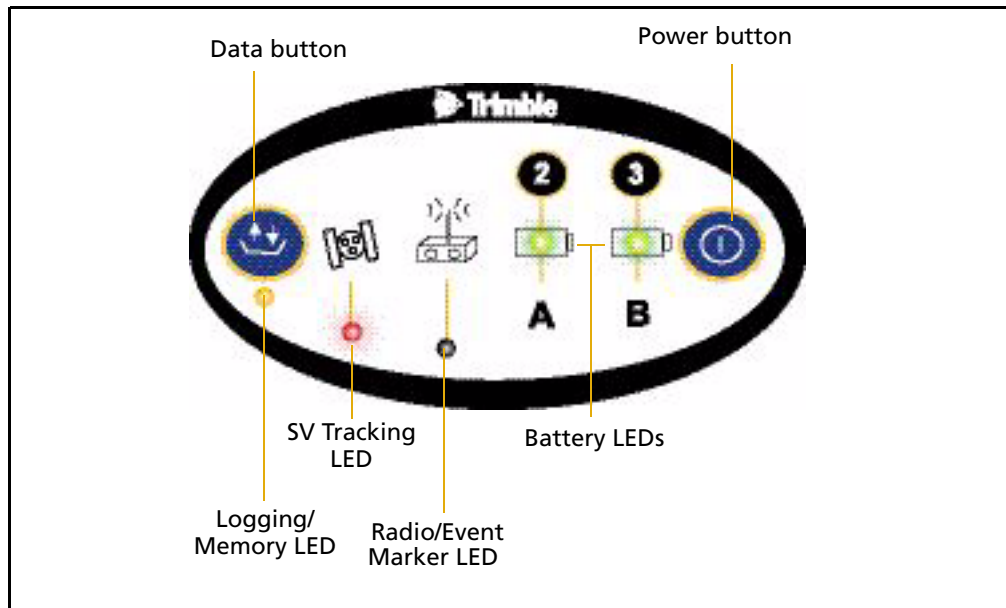



Figure 4.1 Receiver front panel controls and LEDs

Button functions

The receiver has only two buttons: the Power button  and the Data button .

Press  to switch the receiver on or off, and to perform data management functions such as deleting files or resetting the receiver.

Press  to start or stop logging. This button is effective only when the receiver is switched on and has completed any power-up and initialization tasks.

Table 4.1 describes the main functions of the two buttons.

Table 4.1 Button functions

| Action | Power button | Data button |
|----------------------------------------|---------------------|--------------------|
| Turn on the receiver | Press | |
| Turn off the receiver | Hold for 2 seconds | |
| Start logging data internally | | Press |
| Stop logging data internally | | Hold for 2 seconds |
| Delete the ephemeris file | Hold for 15 seconds | |
| Reset the receiver to factory defaults | Hold for 15 seconds | |
| Delete application files | Hold for 30 seconds | |
| Format the CompactFlash card | Hold for 30 seconds | |

Note – The term “press” means to press the button and release it immediately. The term “hold” means to press the button and hold it down for the given time.

LED behavior

The five LEDs on the top panel of the receiver indicate various operating conditions. Generally, a lit or slowly flashing LED indicates normal operation, an LED that is flashing quickly indicates a condition that may require attention, and an unlit LED indicates that no operation is occurring. The following table defines each possible LED state.

| The term ... | means that the LED ... |
|--------------|------------------------------------------------|
| Flash | is lit briefly every 3 seconds |
| Slow flash | alternates slowly between being lit and unlit |
| Fast flash | alternates rapidly between being lit and unlit |
| On | is lit |
| Off | is unlit |

Logging/memory LED

The yellow Logging/memory LED below the  button indicates the status of data logging and memory usage.

| Behavior | Meaning |
|-----------------|------------------------------------------------------------------------------------------------------------------------------------------------------------------------------------------------------------------------------------------------------------|
| On | Data is being logged. |
| Slow flash | Enough FastStatic data has been logged. Alternatively, if the red SV Tracking LED is on solid at the same time and the other LEDs are off, the receiver is in Monitor mode. Turn off the power and then turn it on again to return to normal operation. |
| Fast flash | Data is being logged but memory is low. |
| Very slow flash | The receiver is in Sleep mode, and will wake up five minutes before the scheduled start time of a timed application file. |
| Off | Data is not being logged. |

SV Tracking LED

The red SV Tracking LED below the SV icon  indicates the status of satellite tracking.

| Behavior | Meaning |
|------------|-------------------------------------------------------------------------------|
| Slow flash | Tracking four or more satellites. |
| Fast flash | Tracking three or fewer satellites. |
| Off | Not tracking any satellites. |
| On | The receiver is in Monitor mode, and is checking for new firmware to install. |

Radio LED

The green Radio LED below the Radio icon  indicates the status of data input and output.

| Behavior | Meaning |
|------------|--------------------------------------------------|
| Slow flash | A data packet or event marker has been received. |

Battery 1 LED and battery 2 LED



The Battery LEDs inside the two Battery icons  indicate the status of the two internal batteries, or the power sources connected on Ports 2 and 3.

By default, each battery LED indicates the status of the external power source on the corresponding port. If no external source is detected, each LED indicates the status of an internal battery. The color of the LED indicates whether the power source is currently in use (green) or is on standby (yellow).

| Color | Meaning | Behavior | Meaning |
|--------|----------------------------|------------|----------------------------|
| Green | Power source is in use | On | Healthy |
| | | Fast flash | Low power |
| | | Off | No power source is present |
| Yellow | Power source is on standby | On | Healthy |
| | | Fast flash | Low power |
| | | Flash | Dead |
| | | Off | No power source is present |

Starting and stopping the receiver

To turn on the receiver, press .

To turn off the receiver, hold down . The SV LED turns on, and then turns off after two seconds. When the LED turns off, release ; the receiver turns off.

Logging data

You can log data to the CompactFlash card in the receiver, or to a Trimble controller.

Logging internally

The receiver logs GPS data internally on a CompactFlash card. Use Trimble Business Center to download the T01 formatted files directly from the CompactFlash card to the office computer. Alternatively, you can use the Trimble Data Transfer utility to transfer logged data files to your office computer. The transferred files are in Trimble DAT (.dat) format.

If you use the Data Transfer utility to download the internally-logged files, a DAT (.dat) file is automatically created after the download; DAT files do not contain GLONASS data. These files are appropriate for processing in Trimble Geomatics Office™ software because that software does not process GLONASS data.

If you have the Trimble Business Center software, the T01 file that is stored on the receiver can be directly downloaded; these files contain any collected GLONASS data. The Trimble Business Center software can process GLONASS data, if you have purchased that option.

CAUTION – The receiver allows for more than 500 files on the CompactFlash card, regardless of the card’s capacity. The file names must be in 8.3 format, otherwise, files copied to the CompactFlash card may cause data corruption or loss of data when logging.

Data is logged using the current logging settings configured in the receiver. Data files logged internally are named automatically.

To begin internal logging, press **♥**. The Logging/memory LED lights up.

To stop logging, hold down **♥** for at least two seconds. The Logging/memory LED turns off.

Note – *When the CompactFlash card is full, if auto-delete is not enabled, the receiver stops logging data, and the Logging/memory LED turns off. Existing data files are not overwritten.*

Approximate storage requirements for different logging rates are shown below. The values shown are for a one-hour logging session with six satellites visible.

| Logging rate | Minimum memory required |
|--------------|-------------------------|
| 10 Hz | 2,588 KB |
| 1 Hz | 335 KB |
| 5 seconds | 87 KB |
| 15 seconds | 37 KB |

Note – *If power is lost, or the CompactFlash card is removed while logging, the file system is designed so that a maximum of ten seconds of data will be lost, regardless of the logging rate.*

Logging to a Trimble controller

When the receiver is connected to a Trimble controller, you can log GPS data from the receiver to the controller, or to a data card inserted in the controller. When you use a Trimble controller, you do not use the receiver’s controls. Instead, you use the controller functions to set logging options, specify filenames, and to control when logging occurs.

Controller software job files and the corresponding raw data files can be transferred to an office computer using the Trimble Data Transfer utility.

For more information on logging data from a receiver using a Trimble controller, refer to the user guide for your particular controller.

Resetting to defaults



CAUTION – If you hold down  for more than 30 seconds, any application files stored in the receiver are deleted and the CompactFlash card is reformatted.

To reset the receiver to its factory default settings, hold down  for at least 15 seconds.

Resetting the receiver to its factory defaults also deletes any ephemeris file in the receiver.

For more information, see [Chapter 8, Default Settings](#).

Formatting a CompactFlash card



CAUTION – Formatting a CompactFlash card while it is in the receiver deletes all the data files on the card.

To format a CompactFlash card for use in the receiver, insert the card in the CompactFlash port and then hold down  for at least 30 seconds. After 15 seconds, the receiver is reset to its factory defaults, and any ephemeris file is deleted. After 30 seconds, any files stored on the card are deleted and the CompactFlash card is reformatted.

***Note** – When you use  to format the CompactFlash card, a quick format is performed. A quick format reformats the card for use with the receiver and deletes all data on the card. A full format checks the card for errors or bad sectors, and is only necessary if the card is corrupted. To perform a full format, use the GPS Configurator software. For more information, see [The GPS Configurator software, page 98](#).*

Batteries and power



WARNING – Do not damage the rechargeable Lithium-ion battery. A damaged battery can cause an explosion or fire, and can result in personal injury and/or property damage. To prevent injury or damage:

- Do not use or charge the battery if it appears to be damaged. Signs of damage include, but are not limited to, discoloration, warping, and leaking battery fluid.
 - Do not expose the battery to fire, high temperature, or direct sunlight.
 - Do not immerse the battery in water.
 - Do not use or store the battery inside a vehicle during hot weather.
 - Do not drop or puncture the battery.
 - Do not open the battery or short-circuit its contacts.
-

The receiver can be powered either by its two internal batteries or by an external power source connected to Port 2 or Port 3. The charge provided by the internal batteries depends on the type of survey and operating conditions.

The external power source is always used in preference to the internal batteries. When there is no external power source connected, or if the external power supply fails, the internal batteries are used. The internal batteries are drained in turn, and the receiver automatically switches to the full battery when the first battery is drained.

If no external power is supplied and both internal batteries are drained, none of the data that you have logged is lost. When internal or external power is restored, the receiver restarts in the same state as when power was lost. For example, if the receiver was logging data, the data file is not corrupted, and when power is restored the receiver resumes logging with the same settings as before.

The power supply that comes with the receiver charges the internal batteries while they are still in the receiver. To do this, connect the power supply to the power/serial data cable, connect the cable to Port 2 on the receiver and then connect the power supply to an AC power source, as shown below.

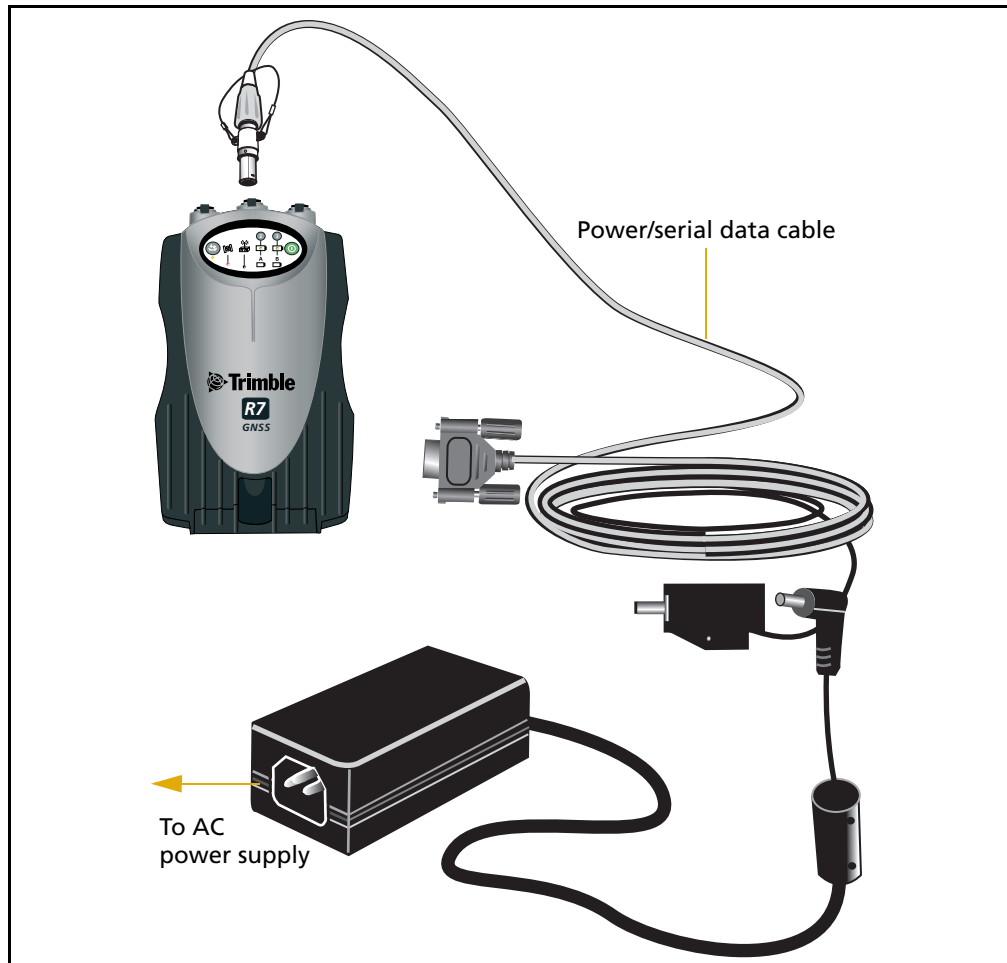

The two internal batteries take approximately eight hours to charge. They are charged individually, so each battery takes approximately four hours to charge. The internal batteries start charging whenever an external power supply of greater than 15 V is detected.



WARNING – Avoid contact with the rechargeable Lithium-ion battery if it appears to be leaking. Battery fluid is corrosive, and contact with it can result in personal injury and/or property damage.

To prevent injury or damage:

- If the battery leaks, avoid contact with the battery fluid.
 - If battery fluid gets into your eyes, immediately rinse your eyes with clean water and seek medical attention. Do not rub your eyes!
 - If battery fluid gets onto your skin or clothing, immediately use clean water to wash off the battery fluid.
-

Each receiver in your system is supplied with two internal Lithium-ion batteries. To charge both sets of batteries, connect both receivers to power supplies as shown in Figure 4.2.

Battery charging and storage

All battery types discharge over time when they are not being used. Batteries also discharge faster in colder temperatures. If a Lithium-ion battery is to be stored for long periods of time, make sure it is fully charged before storing and re-charged at least every three months.



WARNING – Charge and use the rechargeable Lithium-ion battery only in strict accordance with the instructions. Charging or using the battery in unauthorized equipment can cause an explosion or fire, and can result in personal injury and/or equipment damage.

To prevent injury or damage:

- Do not charge or use the battery if it appears to be damaged or leaking.
 - Charge the Lithium-ion battery only in a Trimble product that is specified to charge it. Be sure to follow all instructions that are provided with the battery charger.
 - Discontinue charging a battery that gives off extreme heat or a burning odor.
 - Use the battery only in Trimble equipment that is specified to use it.
 - Use the battery only for its intended use and according to the instructions in the product documentation.
-

Charging the Lithium-ion battery

The rechargeable Lithium-ion battery is supplied partially charged. Charge the battery completely before using it for the first time. If the battery has been stored for longer than six months, charge it before use.

To protect the battery from deep discharge (5 V or less), the receiver is designed to switch batteries or cease drawing power when the battery pack discharges to 5.9 V.

A battery that has reached the deep discharge level cannot be recharged and must be replaced. The following recommendations provide optimal performance and extend the life of your batteries:

- Fully charge all new batteries before use.
- Do not allow the batteries to discharge below 5 volts.

- Keep all batteries on continuous charge when not in use. Batteries may be kept on charge indefinitely without damage to the receiver or batteries.
- Do not store batteries in the receiver or external charger unless power is applied.
- If you must store the batteries, fully charge them before storing and then recharge them at least every three months.

Disposing of the rechargeable Lithium-ion battery

Discharge the Lithium-ion battery before disposing of it. When disposing of the battery, be sure to do so in an environmentally sensitive manner. Adhere to any local and national regulations concerning battery disposal or recycling.

Operating with the controller

If the receiver is being powered by its internal batteries, it does not supply power to the controller when they are connected. The receiver and the Trimble controller must be charged using their own power supplies with connections to the AC power supply from the wall.

Power output

If the receiver is being supplied with power from an external source, power is automatically output on Port 1. Port 1 outputs a maximum voltage of 20 V, even if the input voltage is higher.

You can use GPS Configurator or Trimble Survey Controller software to enable power output on Port 3. Port 3 can be enabled for power output regardless of whether power is supplied internally or externally.

On Port 3, the output voltage is approximately 0.5 V less than the input voltage. For example, if power is being supplied from the internal Lithium-ion batteries, the maximum battery voltage is 8.4 V, so the maximum output voltage is 7.9 V.

***Note** – When you start a survey using the Trimble Survey Controller software, and you are using an external radio, the software automatically enables power output on Port 3.*

Firmware

A receiver's *firmware* is the program inside the receiver that makes the receiver run and controls the hardware. You can upgrade the firmware for the receiver using the WinFlash utility provided on the receiver CD. For more information, see [The WinFlash utility, page 98](#).



CAUTION – Downgrading the firmware deletes all application files on the receiver.

Configuration

In this chapter:

- [Configuring the receiver in real Time](#)
- [Configuring the receiver using application files](#)
- [Application files](#)

The receiver has no controls to change settings. To configure the receiver, use external software, such as GPS Configurator, WinFlash, Trimble Survey Controller, or Trimble Digital Fieldbook.

To configure the receiver, do one of the following:

- Configure the receiver in real time
- Apply the settings in an application file

This chapter provides a brief overview of each of these methods, and describes the contents and use of application files.

Configuring the receiver in real time

The GPS Configurator, Trimble Survey Controller, and Trimble Digital Fieldbook software support real-time configuration of the receiver.

When you configure the receiver in real time, you use one of these software applications to specify which settings you want to change. When you apply the changes, the receiver settings change immediately.

Any changes that you apply to the receiver are reflected in the current application file, which is always present in the receiver. The current application file always records the most recent configuration, so if you apply further changes (either in real time or using an application file) the current file is updated and there is no record of the changes that you applied originally.

For more information on configuring the receiver in real time, see [Chapter D, Software Utilities](#).

Configuring the receiver using application files

An application file contains information for configuring a receiver. To configure a receiver using an application file, you need to create the application file, transfer it to the receiver, and then apply the file settings. The GPS Configurator software does this for you automatically when you work with configuration files.

For more information on applying application files, see [Chapter D, Software Utilities](#).

Application files

Application files store a receiver's configuration for use at a later time.

You can store up to ten different application files in battery-backed memory on the receiver. You can apply an application file's settings at the time it is transferred to the receiver, or at any time afterwards.

Special application files

The receiver has three special application files, which control important aspects of the receiver's configuration.

Default application file

The default application file (Default.cfg) contains the original receiver configuration, and cannot be changed. This file configures the receiver after it is reset. To reset the receiver, hold down the Power button for at least 15 seconds, or use the reset option in the GPS Configurator software.

For more information, see [Default settings, page 62](#).

Although you cannot change or delete the default application file, you can use a power up application file to override any or all of the default settings.

Current application file

The current application file (Current.cfg) reflects the current receiver configuration. Whenever you change the receiver's configuration, either in real time or by applying an application file, the current file changes to match the new configuration.

You cannot delete the current file or change it directly, but every change to the receiver's current configuration is applied to the current file as well.

When you turn off the receiver then turn it on again, all the settings from the current application file are applied, so you do not lose any changes that you have made. The only exceptions are the following logging parameters:

- Logging rate
- Position rate
- Elevation mask

These parameters are always reset to the factory default values whenever the receiver is switched off.

Power up application file

The power up application file (Power_up.cfg) is optional. If a power up file is present, its settings are applied whenever the receiver is turned on.

In this file, you can specify that the receiver is reset to defaults before the power up settings are applied. This ensures that restarting the receiver always results in the same configuration. This method is useful for defining "default" settings for the receiver that differ from those in the default file, which cannot be changed.

Alternatively, you can specify that the power up settings are applied immediately after the current application file's settings have been applied. Restarting the receiver results in a configuration that uses your default settings for the options you define in the power up file, but the current settings for all other options.

By default, there is no power_up application file on the receiver. To use a power up application file, you must create and save a power_up application file in the GPS Configurator software. If you save this file to disk, the file is called power_up.cfg. The extension .cfg is used by convention to identify application files on the office computer. When you transfer this file to the receiver, the file is saved on the receiver as power_up, and becomes the new power up file.

Timed application files

A timed application file contains a Timed Activation record which specifies when this file is to be applied. The main use of a timed application file is to automatically start or stop logging at a predefined time.

The Timed Activation record specifies:

- the UTC date and time when the application file is to be applied for the first time
- the interval at which the file is to be reapplied

If you do not specify a repeat interval, the settings are applied only once, at the specified time. If the file specifies a repeat interval, the file's settings are reapplied at the specified interval until the file is deactivated.

Note – If the receiver is logging continuously, the current logging takes precedence over any timed application file stored in the receiver.

Defining timed application files

To send timed application files to a receiver, set up scheduled survey sessions in the GPS Configurator software. You can define multiple sessions, each specifying:

- basic logging parameters (data logging rate, position logging rate, and elevation mask)
- a starting time
- a duration

When you apply the current settings in the GPS Configurator software, each defined survey session is sent to the receiver as a pair of timed application files: the first includes the logging settings and start time, and the second contains settings that stop logging at the end time (which is calculated automatically from the duration you specify).

For more information on scheduled survey sessions, refer to the GPS Configurator Help.

The receiver can store up to 10 application files, so you can define a maximum of 5 scheduled survey sessions (5 pairs of start/stop timed application files).

Sleep mode

Whenever you press [P] to turn off the receiver, the receiver checks for a timed application file that is due to be activated in the future. If one exists, the receiver goes into Sleep mode instead of turning off.

In Sleep mode, the yellow Logging/memory LED flashes every three seconds. The receiver wakes up five minutes before the scheduled activation time, so that it is ready to begin logging at the scheduled time.

Applying application files

An application file's settings do not affect the receiver's configuration until you **apply** the application file. You can do this at the same time that you save the file.

Alternatively, save the file on the computer or in the receiver, then open it later and apply its settings.

***Note** – If the application file is a timed file, its settings do not take effect as soon as you apply the file, but at the time that the file specifies for its activation.*

Storing application files

You can store application files that you create in the GPS Configurator software on the receiver and on the computer. For example, each file can represent a different user sharing the same receiver, or a particular mode of operation or survey style. Saving application files on your computer as well as in your receiver is optional, but it is useful because:

- it gives you a permanent copy of the settings you have sent to a receiver, for audit or your own reference.
- you can use the same file to configure multiple receivers identically.
- you can use an existing application file as a template to create other application files with similar settings.

Naming application files

The application filename in the office computer and in the receiver is always the same. This makes it easier to recognize and keep track of your application files.

When you change the name of the application file in the receiver, this changes the application filename on your computer. When you transfer an application file from the receiver and save it to the computer, the system renames the file to match the internal receiver file. However, if you use Windows Explorer, for example, to change the .cfg filename on the computer, this **does not** change the internal receiver filename. This means that the GPS receiver does not recognize the change to the filename on the computer.

Transferring Data

In this chapter:

- [Connecting to the office computer](#)
- [Transferring data](#)
- [Transferring files from a CompactFlash card](#)
- [Deleting files in the receiver](#)
- [Supported file types](#)

The receiver keeps satellite measurements and other data in files stored on a CompactFlash card. These files cannot be processed until you transfer them to your office computer.

***Note** – The receiver supports more than 500 files on the CompactFlash cards.*

When you return to the office with a completed survey, transfer the field data to a computer that has the Trimble Business Center software installed. You can then process the survey data in the Trimble Business Center software to produce baselines and coordinates.

Connecting to the office computer

The receiver has three serial (COM) ports and one USB port to connect to the office computer. A USB connection is up to ten times faster than normal serial communications.

Use the standard power/serial data cable to connect the receiver to the computer.

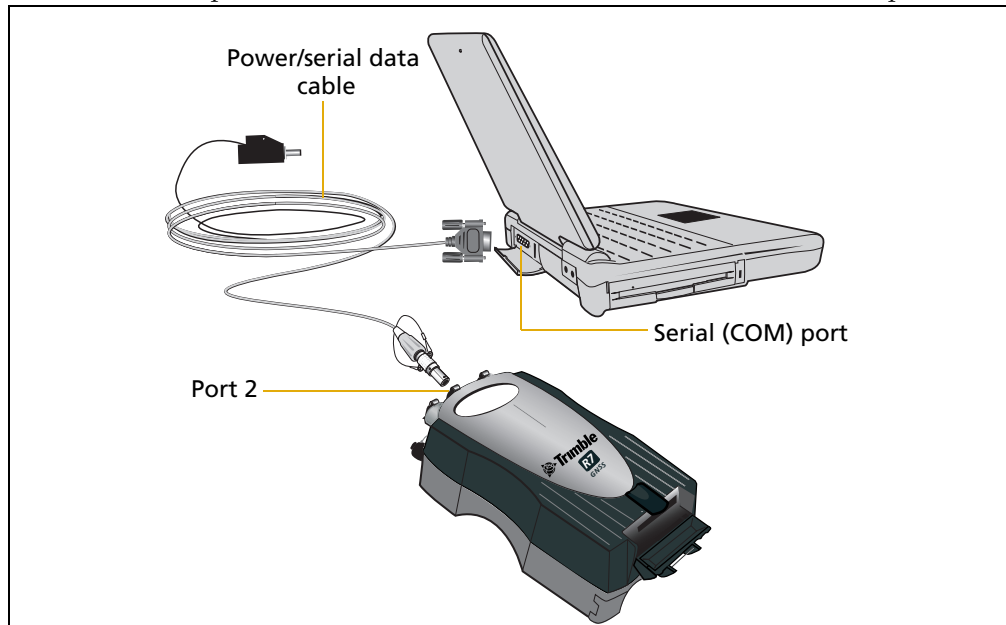

Use the USB cable to connect the receiver to the computer.

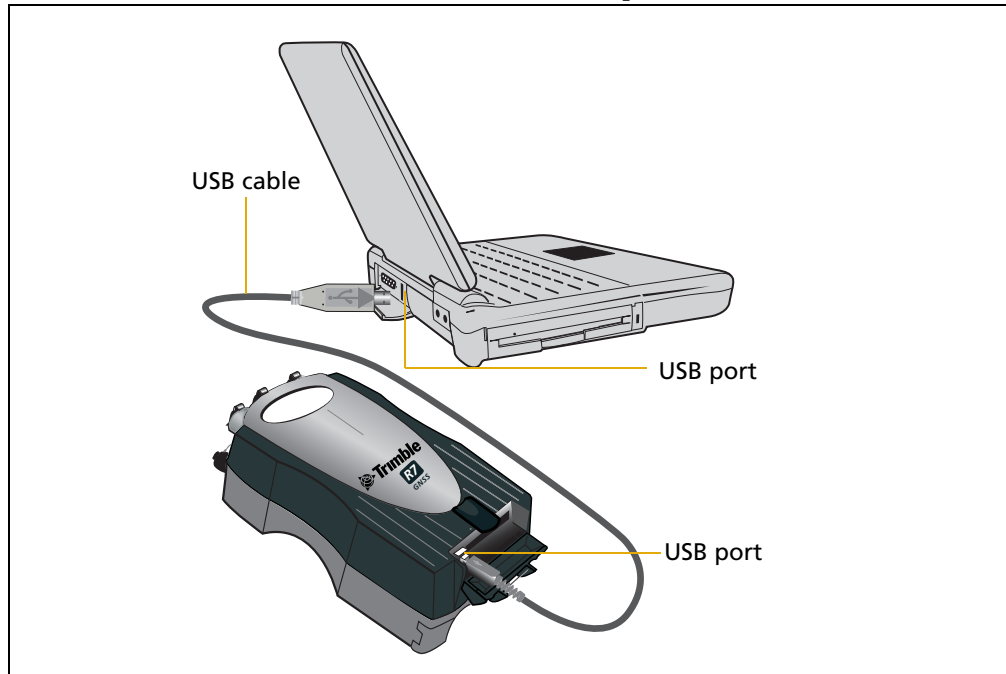

Note – When the receiver is connected to a USB port on a computer, it is treated as a peripheral device of the computer. If the receiver is unplugged or turned off, a warning message appears on the computer.

Transferring data

Transfer the data files to the computer using Trimble Business Center software or the Trimble Data Transfer utility. You can run the Data Transfer utility as a standalone program. For more information, refer to the *Trimble Business Center Help* or the *Data Transfer Help*.

Note – When you connect to a receiver using Trimble Business Center software or in the Data Transfer utility, you must use a GPS Receiver (R/5000 Series) device definition. If you use a GPS Receiver (4000 Series) device definition, the software cannot establish communication with the receiver.

When transfer is complete, the Data Transfer utility automatically converts the file to the DAT format. In doing so, the utility strips out any GLONASS data that was collected using a Trimble R7 GNSS receiver. If you use Trimble Business Center software to download your files, they remain in the native T01 format, and GLONASS data is preserved.

Note – A file in DAT format is approximately six times the size of the corresponding file in the receiver internal (T01) format. Before transferring files using the Data Transfer utility, make sure that there is enough space on your computer.

Transferring files from a CompactFlash card

In a receiver, all data is stored on an internal CompactFlash card. There are different ways to transfer files between the receiver and the office computer:

- Connect the receiver to the office computer and use the Trimble Business Center software to transfer files
- Remove the CompactFlash card from the receiver and connect it directly to your office computer, where it functions like a normal disk drive. Use Windows Explorer to transfer files.
- Connect the receiver to the office computer and use the Data Transfer utility to transfer files.

Transferring files using Trimble Business Center

Trimble Business Center can process the receiver raw data files (T01). To transfer files, connect the computer directly to the receiver, or connect the CompactFlash card to the computer.

No conversions of the T01 files are necessary. Any GPS or GLONASS data in the T01 files is used in the processing of baselines.

Transferring files for processing in Trimble Geomatics Office software

Trimble Geomatics Office software cannot directly import the raw receiver files (T01). They must be converted to the Trimble DAT file format for use.

CAUTION – The conversion of the raw receiver data (T01) files into the Trimble DAT file format results in the loss of any Glonass data that the receiver collected.

When you use the Data Transfer utility to transfer data files from the CompactFlash card while it is still inserted in the receiver, the Data Transfer utility converts the raw receiver data (T01) files you select into the Trimble DAT file format.

However, if you connect the CompactFlash card to your computer and then copy or move files to your computer, it treats the card like any other disk drive, and transfers the files without converting them. You need to convert these raw receiver files to DAT format files before you can use them on your office computer.

You can convert receiver data files using a Windows Explorer extension, which is installed on your computer when you install the Data Transfer utility.

Note – Although this extension is only available if you have the Data Transfer utility installed, you do not have to run the Data Transfer utility to use it.

To convert a T01 file on your office computer into the DAT format:

1. On your office computer, open Windows Explorer and navigate to the location of the T01 file.
2. Right-click the file, and select *Convert to DAT format* from the shortcut menu:

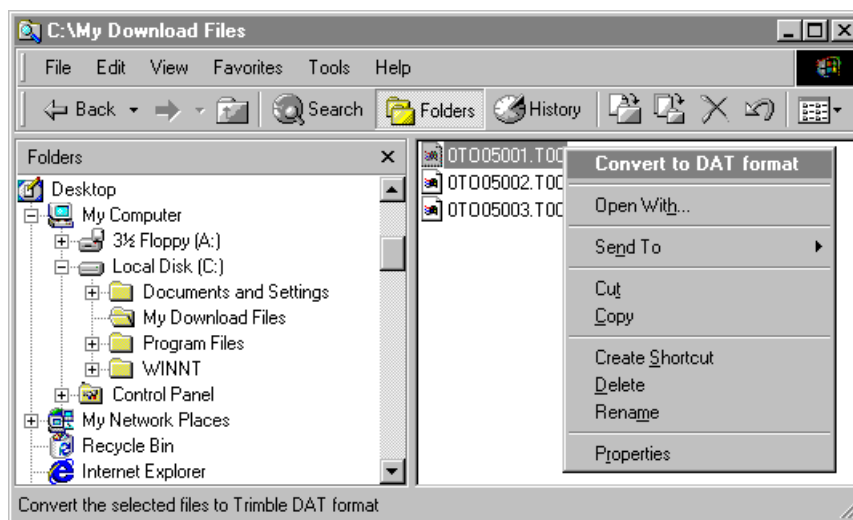

The *DAT File Conversion* dialog appears while the file is converted. When the dialog disappears, the file conversion is complete.

A new file with the same filename but a .dat extension appears in the same folder as the T01 file.

Deleting files in the receiver

You can delete files stored in the receiver at any time. Do one of the following:

- Use the Data Transfer utility or the Trimble Business Center software.
- Use the controller.
- Turn on the receiver and then hold down **[P]** for 30 seconds. When you use this method, **all** data is deleted, and the CompactFlash card is reformatted.
- Use the GPS Configurator software.

Supported file types

Table 6.1 shows the file types that you can transfer to or from a receiver, and the software or utility that you must use to transfer each file type.

Table 6.1 Supported file types

| File Type | Extensions | Transfer from receiver? | Transfer to receiver? | Software / utility |
|-------------------------|------------|-------------------------|-----------------------|------------------------------------------|
| Ephemeris | .eph | Yes | No | Data Transfer or Trimble Business Center |
| Raw observations | .T01, .dat | Yes | No | Data Transfer or Trimble Business Center |
| Receiver firmware files | .elf | No | Yes | WinFlash |
| Application files | .cfg | Yes | Yes | GPS Configurator |

Note – The receiver supports more than 500 files on the CompactFlash card. Files stored on the compact flash must be 8.3 format. The receiver does not support extended file names.

Specifications

In this chapter:

- [Physical specifications](#)
- [Positioning specifications](#)
- [Technical specifications](#)

This chapter lists the receiver specifications. Where specifications apply to only one receiver model, this is clearly indicated.

Physical specifications

| Feature | Specification |
|-----------------------------------------------------------|------------------------------------------------------------------------------|
| Size | 13.5 cm W x 8.5 cm H x 24 cm L (5.3 in. W x 3.4 in. H x 9.5 in. L) |
| Weight (with 2 batteries inserted) | 1.5 kg (3.1 lb) |
| Operating times (with two 2.4 Ah batteries) (at 20 °C) | RTK with Internal Radio: 6-8 hours Post Processed: > 10 hours |
| Power input | 10.5-28 V DC, with over-voltage protection |
| Operating temperature | -40 °C to +65 °C (-40 °F to +149 °F) |
| Storage temperature | -40 °C to +80 °C (-40 °F to +176 °F) |
| Humidity | 100% condensing, unit fully sealed |
| Casing | Tough, lightweight, fully sealed magnesium alloy |
| Water/dustproof | IP67 dustproof, protected from temporary immersion to depth of 1 m (3.28 ft) |

The receiver will operate normally to -40 °C; internal batteries are rated to -20 °C. The temperature rating of the receiver applies only when all doors on the receiver are closed.

Positioning specifications

| Feature | Specification |
|--------------------------------------------------------|----------------------|
| Code differential GPS positioning^a | |
| Horizontal | ±0.25 m + 1 ppm RMS |
| Vertical | ±0.50 m + 1 ppm RMS |
| WAAS differential positioning accuracy ^b | typically <5 m 3DRMS |
| Static and FastStatic GPS surveying^a | |
| Horizontal | ±5 mm + 0.5 ppm RMS |
| Vertical | ±5 mm + 1 ppm RMS |
| Kinematic surveying^a | |
| Horizontal | ±10 mm + 1 ppm RMS |
| Vertical | ±20 mm + 1 ppm RMS |

^a Accuracy and reliability may be subject to anomalies due to multipath, obstructions, satellite geometry, and atmospheric conditions. Always follow recommended survey practices.

^b Depends on WAAS/EGNOS system performance.

Technical specifications

| Feature | Specification |
|-------------------------------------------|-------------------------------------------------------------------------------------------------------------------------------------------------------------------------------------------------------------------------------------|
| Tracking | |
| Trimble R7 GNSS receiver | 72 Channels GPS L1 C/A Code, L2C, L1/L2/L5 Full Cycle Carrier, GLONASS L1 C/A Code, L1 P Code, L2 P Code, L1/L2 Full Cycle Carrier, 4 additional channels for SBAS WAAS/EGNOS support Fully operational during P-code encryption |
| R5 GPS receiver | 72 Channels GPS L1 C/A Code, L2C, L1/L2 Full Cycle Carrier, GLONASS L1 C/A Code, L1 P Code, L2 P Code, L1/L2 Full Cycle Carrier, 4 additional channels for SBAS WAAS/EGNOS support Fully operational during P-code encryption |
| Signal processing | Advanced Trimble Maxwell™ Custom Survey GNSS chip Very low-noise GNSS carrier phase measurements with <1 mm precision in a 1 Hz bandwidth Multipath suppression |
| Initialization | Automatic while moving or static |
| Initialization time ^a | Typically, <10 seconds (Trimble R7 GNSS) receiver Typically, <20 seconds (Trimble R5 GPS receiver) |
| Initialization reliability ^b . | Typically, >99.9% |
| Communications | Three RS-232 serial ports (Port 1, Port 2, and Port 3) Baud rates up to 115,200 bps RTS/CTS flow control negotiation supported on Port 3 only One USB port (download only) |
| Configuration | Via user-definable application files or GPS Configurator |
| Output formats | NMEA-0183: AVR; GGA; GSA; GST; GSV; PTNL,GGK; PTNL,GGK_SYNC; HDT; PTNL,PJK; PTNL,PJT; ROT PTNL,VGK; VHD; VTG; ZDA GSOF (Trimble Binary Streamed Output) 1PPS RT17 |

^a May be affected by atmospheric conditions, signal multipath, obstructions and satellite geometry.

^b May be affected by atmospheric conditions, signal multipath, and satellite geometry. Initialization reliability is continuously monitored to ensure highest quality.

Default Settings

In this chapter:

- [Default settings](#)
- [Resetting to factory defaults](#)
- [Default behavior](#)
- [Power up settings](#)

All receiver settings are stored in application files. The default application file, `Default.cfg`, is stored permanently in the receiver, and contains the factory default settings for the receiver.

Whenever the receiver is reset to its factory defaults, the current settings (stored in the current application file, `current.cfg`) are reset to the values in the default application file.

You cannot modify the default application file. However, if there is a power up application file (`Power_up.cfg`) in the receiver, the settings in this file can be applied immediately after the default application file, overriding the factory defaults.

For more information, see [Application files](#), page 46.

Default settings

These settings are defined in the default application file.

| Function | | Factory Default |
|---------------------------|------------------------|------------------------------|
| SV Enable | | All SVs enabled |
| General Controls: | Elevation mask | 13° |
| | PDOP mask | 7 |
| | RTK positioning mode | Low Latency |
| | Motion | Kinematic |
| Power Output 3 | | Disabled |
| 1PPS time tags | | Off |
| ASCII time tags | | Off |
| Serial Port 1: | Baud rate | 38400 |
| | Format | 8-None-1 |
| | Flow control | None |
| Serial Port 2: | Baud rate | 38400 |
| | Format | 8-None-1 |
| Serial Port 3: | Baud rate | 38400 |
| | Format | 8-None-1 |
| | Flow control | None |
| Input Setup: | Station | Any |
| NMEA/ASCII (all messages) | | All Ports Off |
| Streamed output | | All Types Off Offset = 00 |
| RT17/Binary | | All Ports Off |
| CMR output | | [Static] CMR: cref ID 0000 |
| RTCM output | | RTCM: Type 1 ID 0000 |
| Reference position: | Latitude | 0° |
| | Longitude | 0° |
| | Altitude | 0.00 m HAE |
| Antenna: | Type | Unknown external |
| | Height (true vertical) | 0.00 m |
| | Group | All |
| | Measurement method | Bottom of antenna mount |
| Logging rate | | 15 sec |
| Position rate | | 5 min |
| Measurement rate | | 10 Hz |

Resetting to factory defaults

To reset the receiver to its factory defaults, do one of the following:

- On the receiver, press and hold down **[P]** for 15 seconds.
- In the GPS Configurator software, select *Connect to Receiver* and then click **Reset receiver** in the *General* tab.

Default behavior

The factory defaults are applied whenever you start the receiver. If a power up file is present in the receiver, its settings are applied immediately after the default settings, so you can use a power up file to define your own set of defaults.

| When you turn the receiver on and ... | then logging settings are ... | and logging ... |
|------------------------------------------------------|-------------------------------------------------------------------|------------------------------|
| it is the first time that the receiver has been used | the factory defaults | does not begin automatically |
| you have reset the receiver to its factory defaults | the factory defaults, or those in the power up file ^a | does not begin automatically |
| you have performed a full reset | the factory defaults, because resetting deletes any power up file | does not begin automatically |

^aA factory default setting is used only if the setting is not defined in the power up file.

Power up settings

When you turn the receiver off, any changes that you have made to logging settings are lost and these settings are returned to the factory defaults. Other settings remain as defined in the current file. The next time you turn on the receiver, the receiver checks for a power up file and, if one is present, applies the settings in this file.

| When you use [P] to turn the receiver off then on again and ... | then logging settings are ... | and all other settings are ... |
|------------------------------------------------------------------------|------------------------------------------------------------------|--------------------------------------------------------------------|
| you changed the receiver settings by applying an application file | the factory defaults | the last settings used |
| you changed the receiver settings using configuration software | the factory defaults | the last settings used |
| there is a power up application file in the receiver | the factory defaults, or those in the power up file ^a | the last settings used, or those in the power up file ^a |

^aA factory default setting is used only if the setting is not defined in the power up file.

Logging after power loss

If the receiver loses power unexpectedly, when power is restored the receiver tries to return to the state it was in immediately before the power loss. The receiver does not reset itself to defaults or apply any power up settings. If the receiver was logging when power was lost unexpectedly, it resumes logging when power is restored.

However, when you turn off the receiver using **[P]**, the receiver behaves as if you pressed **[D]** to stop logging before you pressed **[P]**. In this case, when power is restored normally, logging does not begin until you start it manually.

| When the receiver is logging data and then loses power ... | then when power is restored, data logging ... | and logging settings are ... | and all other settings are ... |
|------------------------------------------------------------|-----------------------------------------------|------------------------------|--------------------------------|
| unexpectedly | resumes automatically | the last settings used | the last settings used |
| when you press [P] | does not resume | the factory defaults | the last settings used |

Disabling logging

To disable logging, you can set the receiver's data logging and position logging rates to Off. However, if you press **[D]** while logging is disabled, the receiver will still log data, using the default logging settings.

| When you have disabled logging ... | then if you press [D] to start logging, logging settings are ... |
|------------------------------------------------------------------|-------------------------------------------------------------------------|
| using the Trimble Survey Controller or GPS Configurator software | the factory defaults |
| in the power up application file | the factory defaults |

Application files

You can use application files to change the settings in the receiver. Sending an application file to the receiver does not necessarily apply the file's settings; you can apply a file's settings at any time after sending it to the receiver. You can also define timed application files. A timed application file contains receiver settings, but also includes a date and time when it is automatically activated.

If there is a timed application file on the receiver, the receiver automatically applies the file's settings and begins logging (if logging settings are included in the file) at the specified time. If the receiver is in Sleep mode, it wakes up five minutes before the start time of the timed application file, and then begins logging, if required, at the specified start time.

| When you send an application file to the receiver and ... | then the receiver settings are changed ... |
|-----------------------------------------------------------|----------------------------------------------|
| you apply the file's settings immediately | as soon as you send the file to the receiver |

When you send an application file to the receiver and ... then the receiver settings are changed ...

| | |
|--------------------------------|----------------------------------|
| you apply the file later | as soon as you apply the file |
| it is a timed application file | at the specified activation time |

Cables and Connectors

In this chapter:

- Port 1, 2, and 3 connectors
- Power/serial data cable
- Event marker/IPPS cable
- GPS antennas and cables

This chapter describes the pinouts for the receiver standard and optional cables. This information can be used to build special cables for connecting the receiver to devices and instruments not supported by the standard and optional cables.

Port 1, 2, and 3 connectors

The following figures show the receiver serial ports and the port pinouts.

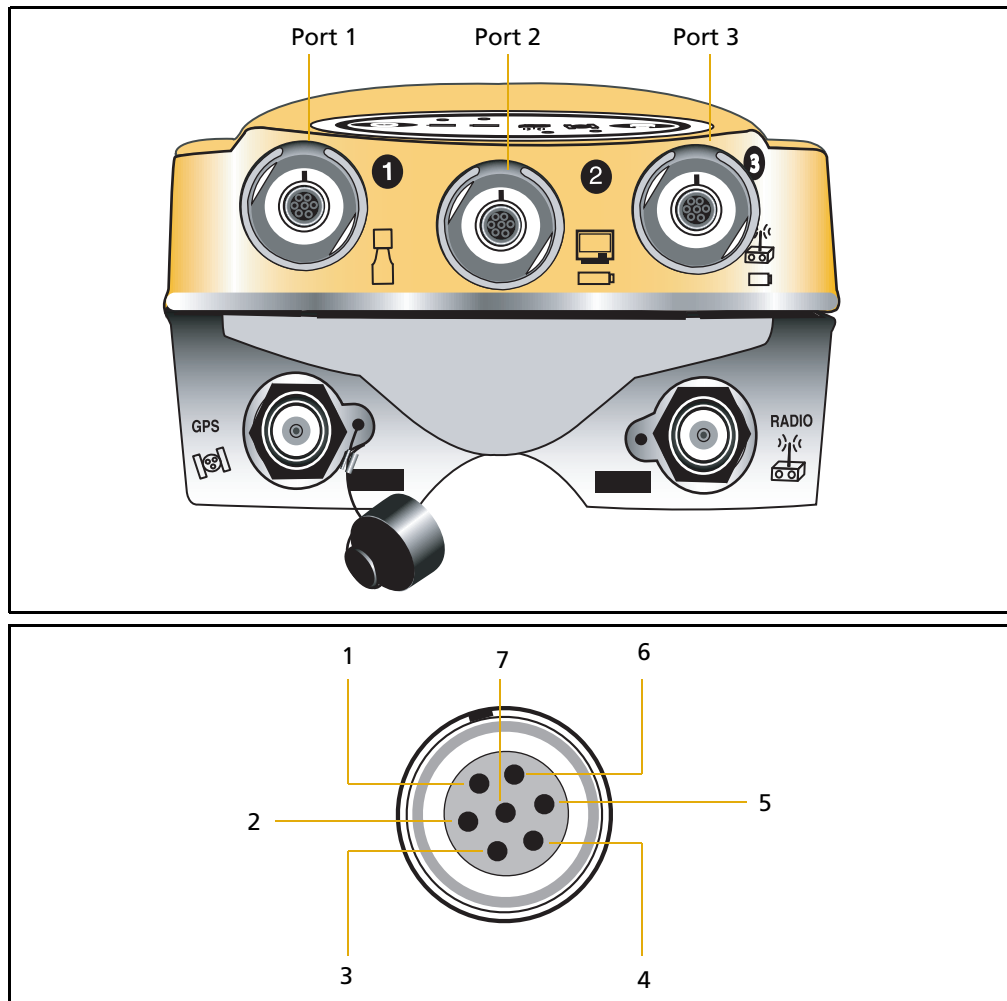

Table 9.1 receiver port pinout functions

| Pin | Pinout function | | |
|-----|-------------------------------------------------------|--------------------------------------------------|-------------------------------------------|
| | Port 1 (Trimble controller, event, or computer) | Port 2 (Power in, computer, PPS, or event) | Port 3 (External radio or power in) |
| 1 | Signal GND | Signal GND | Signal GND |
| 2 | GND | GND | GND |
| 3 | TX data out (TXD1) | TX data out (TXD2) | TX data out (TXD3) |
| 4 | RTS1 | 1PPS | RTS3 |
| 5 | CTS1/Event 2 | Event 1 | CTS3 |
| 6 | Power Out (+) | Power In (+) | Power In/Out (+) |
| 7 | Serial data in (RXD1) | Serial data in (RXD2) | Serial data in (RXD3) |

Power/serial data cable

The power/serial data cable (P/N 59044) is supplied with the receiver.

Table 9.2 Power/serial data cable pinouts

| Lemo 0-shell connector 7 Pin | | Direction | DE9-F connector 7 Conductors | | | Power lead 2 Conductors | |
|---------------------------------|---------------|-----------|---------------------------------|--------|---------------|----------------------------|--------------|
| Pin | Function | | Pin | Color | Function | Color | Function |
| 1 | Signal ground | ↔ | 5 | Brown | Signal ground | | |
| 2 | GND | → | | | | Black | V-OUT |
| 3 | TXD | → | 2 | Orange | TXD | | |
| 4 | RTS/TXD | → | 8 | Blue | RTS | | |
| 5 | CTS/RXD | ← | 7 | Green | CTS | | |
| 6 | PWR | ← | | | | Red | Power IN (+) |
| 7 | RXD | ← | 3 | Yellow | TXD | | |

Note – Table 9.2 assumes that the cable is attached to the connector labeled Port 1 or Port 3.

Event marker/1PPS cable

The event marker/1PPS cable shown below provides a breakout box with two BNC (female) connectors for 1PPS input and event marker output.

Connect a device that accepts 1PPS output pulses to the BNC connector labeled 1PPS on the breakout box. Connect a device that outputs event marker pulses to the receiver, such as a photogrammetric camera, to the BNC connector labeled Event Marker on the breakout box.

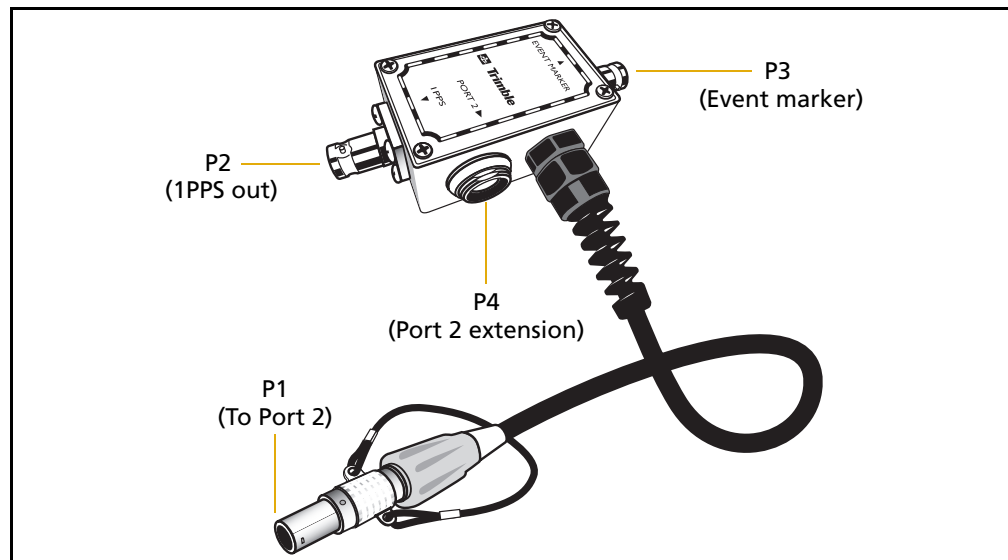

In addition, the breakout box includes a Lemo 7-pin connector to extend serial communications and/or power on Port 2. Because the BNC connectors are used to service the event marker and 1PPS features, pins 4 (1PPS) and 5 (Event Marker) are inactive on the Lemo connector.

For Port 2 pinouts, see [Port 1, 2, and 3 connectors, page 68](#). For more information on 1PPS input and event marker output, see [Chapter 10, Event Marker Input and 1PPS Output](#).

The following pinouts are for the event marker/1PPS cable, which is supplied with the receiver. The event marker/1PPS cable is used only with the receiver connectors labeled Port 1 (for event marker output) and Port 2.

| P1: Lemo 7-Pin Port 2 receiver | | Direction | P2: BNC-F connector (1PPS) | P3: BNC-F connector (Event marker) | P4: Lemo 7s Port 2 extension | |
|--------------------------------|------------------------|-----------|----------------------------|------------------------------------|------------------------------|-----------------------|
| Pin | receiver function | | Pin | Pin | Pin | Function |
| 1 | Signal ground | ← | | | 1 | Signal ground |
| 2 | GND | → | GND | GND | 2 | GND |
| 3 | Serial data out (TXD2) | ← | | | 3 | Serial data in (TXD2) |
| 4 | 1PPS | ← | Center pin | | 4 | No Connect |
| 5 | Event Marker | ↔ | | Center pin | 5 | No Connect |

| P1: Lemo 7-Pin Port 2 receiver | | Direction | P2: BNC-F connector (1PPS) | P3: BNC-F connector (Event marker) | P4: Lemo 7s Port 2 extension | |
|--------------------------------|-----------------------|-----------|----------------------------|------------------------------------|------------------------------|------------------------|
| Pin | receiver function | | Pin | Pin | Pin | Function |
| 6 | Power IN (+) | → | | | 6 | Power IN (+) |
| 7 | Serial data in (RXD2) | ← | | | 7 | Serial data out (RXD2) |

GPS antennas and cables

The antenna that a receiver uses to collect satellite signals is sometimes called a GPS antenna to distinguish it from a radio antenna. Radio antennas are used for communication between receivers and external networks or systems.

***Note** – Choke Ring antennas or older models, such as Micro-Centered L1/L2, have different power requirements. The receiver can adjust the antenna power output when you designate the appropriate antenna in the GPS Configurator software. For more information, see [Antennas](#), page 33.*

Connect the receiver to its GPS antenna using the yellow TNC connector. Use a coaxial cable with a right-angle TNC plug at the antenna end.

| If the antenna cable length is ... | use ... |
|------------------------------------|----------------------------------------------------------------------------------------------------------------------------------------------------------------------|
| up to 15 meters (45 feet) | RG-58 cable |
| up to 30 meters (100 feet) | RG-214 cable |
| over 30 meters (100 feet) | one of the following: <ul style="list-style-type: none"> • in-line amplifier • semi-rigid coaxial cable • a low-loss cable assembly |

Event Marker Input and 1PPS Output

In this chapter:

- [Event marker input](#)
- [1PPS output](#)

The receiver can accept event marker input on Port 1 and port 2, and can generate 1PPS output on Port 2.

Event marker input

Use event marker input to log a precise GPS time tag whenever an externally generated pulse is received, such as one generated at the time of the shutter closing from a photogrammetric camera.

The event is triggered when the source pulse voltage transitions between 1.0 V DC and 2.0 V DC in less than 100 nsec. Trimble recommends that you use TTL level inputs. You can configure the receiver to recognize either a positive (rising) or negative (falling) voltage as the leading edge of a pulse. The accuracy of the associated time tag recorded for an event is determined by the GPS accuracy (typically less than 1 μ sec.).

The receiver records each event in the current data file. This record includes the port on which the event was received.

Enabling and configuring event marker input

To enable or configure the event marker input function, you need the GPS Configurator software.

In real time

You can use the GPS Configurator software to configure a Trimble GPS receiver connected to your office computer. For more information, see [The GPS Configurator software, page 98](#), or refer to the *GPS Configurator Help*.

To enable event marker input:

1. Connect the computer to the receiver.
2. Press **P** to turn on the receiver.
3. To start the GPS Configurator software, click  and then select *Programs / Trimble / GPS Configurator / GPS Configurator*. The *GPS Configurator* dialog appears and the software automatically connects to the receiver.
4. In the *General* tab, select the *Event marker* check box.
5. Select the appropriate option, Positive slope or Negative slope, depending on the type of pulse the external device uses.
6. Click **Apply**.

The GPS Configurator software sends the new configuration information to the receiver, and the receiver starts to accept event marker input.

7. Click **OK** to exit the GPS Configurator software.

The software disconnects from the receiver.

1PPS output

The receiver can output a one pulse per second (1PPS) time strobe with an associated ASCII time tag output. The pulse is output through port 2 of the receiver using the event marker/1PPS cable.

1PPS pulse definition

The leading edge of the pulse coincides with the beginning of each UTC second, as shown below. The pulse is driven by an RS-422 driver between nominal levels of 0 V and 4 V. The leading edge is positive, rising from 0 V to 4 V.

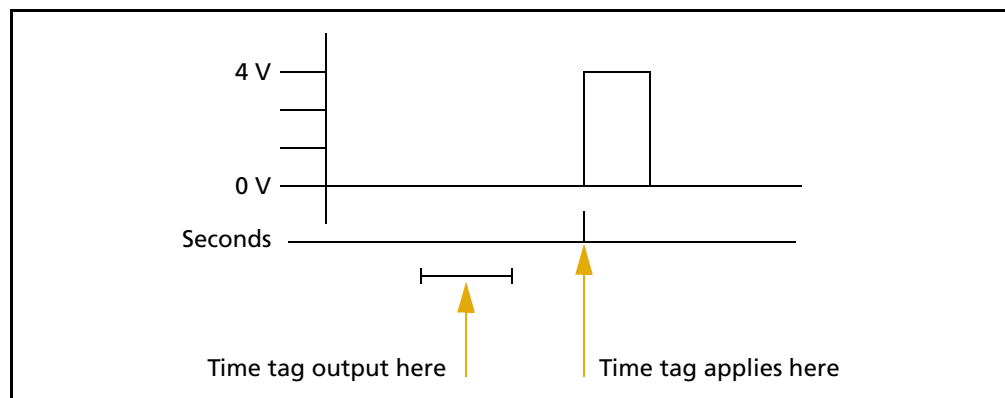

The pulse is approximately 8 μ sec wide, with rise and fall times of about 100 nsec. Resolution is approximately 40 nsec, but several external factors limit accuracy to approximately $\pm 1 \mu$ sec:

- Position errors, especially with user-entered reference. Each meter of error can result in 3 nsec of error in the 1PPS pulse.
- Antenna cable length. Each meter of cable adds a delay of about 2 nsec to satellite signals, and a corresponding delay in the 1PPS pulse.

ASCII time tag definition

Each time tag is output about 0.5 second before the corresponding pulse, as shown above. Time tags are in ASCII format on a user-selected serial port. The format of a time tag is:

UTC yy.mm.dd hh:mm:ss ab

Where:

- *UTC* is fixed text.
- *yy.mm.dd* is the year, month, and date.
- *hh:mm:ss* is the hour (on a 24-hour clock), minute, and second. The time is in UTC, not GPS time.
- *a* is the position-fix type:

- 1 = 2D Position Fix for E,N only
- 2 = 3D Position Fix
- 3 = Single SV Clock-only fix
- 4 = Automatic Mode
- 5 = Reference Station Position
- 6 = Two-Dimensional with Fixed Clock
- 7 = Overdetermined solution for Clock-only

- *b* is the number of satellites being tracked: 1 to 9, “:” (for 10), “;” (for 11), or “<” (for 12).
- Each time tag is terminated by a *carriage return, line feed* sequence.

A typical printout looks like this:

```
UTC 93.12.21 20:21:16 56
UTC 93.12.21 20:21:17 56
UTC 93.12.21 20:21:18 56
```

If the fields “*a*” and “*b*” appear as “??”, the time is based on the receiver clock because the receiver is not tracking satellites. The receiver clock is less accurate than time readings extracted from satellite signals.

Enabling and configuring 1PPS output in real time

To enable or configure the 1PPS output function, you need the GPS Configurator software. You can use the GPS Configurator software to configure a Trimble GPS receiver connected to your office computer. For more information, see [The GPS Configurator software, page 98](#), or refer to the *GPS Configurator Help*.

1. Connect the computer to the receiver.
2. Turn on the receiver.
3. To start the GPS Configurator software, click  and then select *Programs / Trimble / GPS Configurator / GPS Configurator*. The *GPS Configurator* dialog appears and the software automatically connects to the receiver.
4. Select the *Serial outputs* tab.
5. Select the *1PPS (Port 2 only)* check box.
6. If you want ASCII time tags enabled, select the check box and choose an output port.
7. Click **Apply**.

The GPS Configurator software sends the new configuration information to the receiver, and the receiver starts to generate 1PPS output on Port 2.

8. Click **OK** to exit the GPS Configurator software.

The software disconnects from the receiver.

NMEA-0183 Output

In this appendix:

- [NMEA-0183 Outputs](#)
- [Common Message Elements](#)
- [NMEA Messages](#)

This appendix describes the formats of the subset of NMEA-0183 messages that are available for output by the receiver.

For a copy of the NMEA-0183 Standard, go to the National Marine Electronics Association website at www.nmea.org.

NMEA-0183 Outputs

When NMEA-0183 output is enabled, a subset of NMEA-0183 messages can be output to external instruments and equipment connected to the Trimble receiver serial ports. These NMEA-0183 messages let external devices use selected data collected or computed by the receiver.

All messages conform to the NMEA-0183 version 3.01 format. All begin with \$ and end with a carriage return and a line feed. Data fields follow comma (,) delimiters and are variable in length. Null fields still follow comma (,) delimiters but contain no information.

An asterisk (*) delimiter and checksum value follow the last field of data contained in an NMEA-0183 message. The checksum is the 8-bit exclusive *OR* of all characters in the message, including the commas between fields, but not including the \$ and asterisk delimiters. The hexadecimal result is converted to two ASCII characters (0–9, A–F). The most significant character appears first.

The following table summarizes the set of NMEA messages supported by the receiver, and shows the page where detailed information about each message can be found.

| Message | Function | Page |
|---------------|-------------------------------------------------------------------------------|------|
| AVR | Time, yaw, tilt, range, mode, PDOP, and number of SVs for Moving Baseline RTK | 80 |
| GGA | Time, position, and fix related data | 80 |
| GSA | GNSS DOP and active satellites | 81 |
| GST | Position error statistics | 82 |
| GSV | Number of SVs in view, PRN, elevation, azimuth, and SNR | 82 |
| HDT | Heading from True North | 83 |
| PTNL,GGK | Time, position, position type and DOP values | 83 |
| PTNL,GGK_SYNC | Time, synchronized position, position type and DOP values | 84 |
| PTNL,PJK | Local coordinate position output | 85 |
| PTNL,PJT | Projection type | 85 |
| PTNL,VGK | Time, locator vector, type and DOP values | 86 |
| PTNL,VHD | Heading Information | 86 |
| RMC | Position, Velocity, and Time | 87 |
| ROT | Rate of turn | 87 |
| VTG | Actual track made good and speed over ground | 88 |
| ZDA | UTC day, month, and year, and local time zone offset | 88 |

To enable or disable the output of individual NMEA messages, do one of the following:

- Create an application file in the GPS Configurator software that contains NMEA output settings and then send the file to the receiver.
- Add NMEA outputs in the *Serial outputs* tab of the GPS Configurator software and then apply the settings.

Common Message Elements

Each message contains:

- A message ID consisting of *\$GP* followed by the message type. For example, the message ID of the GGA message is *\$GPGGA*.
- A comma
- A number of fields, depending on the message type, separated by commas
- An asterisk
- A checksum value

Below is an example of a simple message with a message ID (*\$GPGGA*), followed by 13 fields and a checksum value:

```
$GPGGA,172814.0,3723.46587704,N,12202.26957864,W,2,6,1.2,18.893,M,-  
25.669,M,2.0,0031*4F
```

Message values

The following values can be found in NMEA messages that the receiver generates.

Latitude and longitude

Latitude is represented as *ddmm.mmmm* and longitude is represented as *dddmm.mmmm*, where:

- *dd* or *ddd* is degrees
- *mm.mmmm* is minutes and decimal fractions of minutes

Direction

Direction (north, south, east, or west) is represented by a single character: *N*, *S*, *E*, or *W*.

Time

Time values are presented in Universal Time Coordinated (UTC) and are represented as *hhmmss.cc*, where:

- *hh* is hours, from 00 to 23
- *mm* is minutes
- *ss* is seconds
- *cc* is hundredths of seconds

NMEA Messages

When NMEA-0183 output is enabled, the following messages can be generated.

AVR Time, Yaw, Tilt, Range for Moving Baseline RTK

The AVR message string is shown below, and [Table A.1](#) describes the message fields.

```
$PTNL,AVR,181059.6,+149.4688,Yaw,+0.0134,Tilt,,60.191,3,2.5,6*00
```

Table A.1 AVR message fields

| Field | Meaning |
|-------|---------------------------------------------------------------------------------------------------------------------------------------------------------------------------------------------------------------------------------------|
| 1 | UTC of vector fix |
| 2 | Yaw angle in degrees |
| 3 | Yaw |
| 4 | Tilt angle in degrees |
| 5 | Tilt |
| 6 | Reserved |
| 7 | Reserved |
| 8 | Range in meters |
| 9 | Quality indicator: 0: Fix not available or invalid 1: Autonomous GPS fix 2: Differential carrier phase solution RTK (Float) 3: Differential carrier phase solution RTK (Fix) 4: Differential code-based solution, DGPS |
| 10 | PDOP |
| 11 | Number of satellites used in solution |

GGA Time, Position, and Fix Related Data

An example of the GGA message string is shown below. [Table A.2](#) describes the message fields.

```
$GPGGA,172814.0,3723.46587704,N,12202.26957864,W,  
2,6,1.2,18.893,M,-25.669,M,2.0,0031*4F
```

Table A.2 GGA message fields

| Field | Meaning |
|-------|------------------------------------------------|
| 1 | UTC of position fix |
| 2 | Latitude |
| 3 | Direction of latitude: N: North S: South |
| 4 | Longitude |

Table A.2 GGA message fields (continued)

| Field | Meaning |
|-------|-------------------------------------------------------------------------------------------------------------------------------------------------------------------------|
| 5 | Direction of longitude: E: East W: West |
| 6 | GPS Quality indicator: 0: Fix not valid 1: GPS fix 2: Differential GPS fix 4: Real Time Kinematic, fixed integers 5: Real Time Kinematic, float integers |
| 7 | Number of SVs in use, range from 00 to 12 |
| 8 | HDOP |
| 9 | Orthometric height (MSL reference) |
| 10 | M: unit of measure for height is meters |
| 11 | Geoid separation |
| 12 | M: geoid separation is measured in meters |
| 13 | Age of differential GPS data record, Type 1 or Type 9. Null field when DGPS is not used. |
| 14 | Reference station ID, ranging from 0000 to 1023. A null field when any reference station ID is selected and no corrections are received. |

GSA GNSS DOP and active satellites

An example of the GSA message string is shown below. [Table A.3](#) describes the message fields.

```
$GPGSA,<1>,<2>,<3>,<3>,,,,,<3>,<3>,<3>,<4>,<5>,<6>*<7><CR><LF>
```

Table A.3 GSA message fields

| Field | Meaning |
|-------|---------------------------------------------------------------------------|
| 1 | Mode 1, M = manual, A = automatic |
| 2 | Mode 2, Fix type, 1 = not available, 2 = 2D, 3 = 3D |
| 3 | PRN number, 01 to 32, of satellite used in solution, up to 12 transmitted |
| 4 | PDOP-Position dilution of precision, 0.5 to 99.9 |
| 5 | HDOP-Horizontal dilution of precision, 0.5 to 99.9 |
| 6 | VDOP-Vertical dilution of precision, 0.5 to 99.9 |
| 7 | Checksum |

GST Position Error Statistics

An example of the GST message string is shown below. [Table A.4](#) describes the message fields.

```
$GPGST,172814.0,0.006,0.023,0.020,273.6,
0.023,0.020,0.031*6A
```

Table A.4 GST message fields

| Field | Meaning |
|-------|----------------------------------------------------------------------------------------------------------------------------------|
| 1 | UTC of position fix |
| 2 | RMS value of the pseudorange residuals (includes carrier phase residuals during periods of RTK(float) and RTK(fixed) processing) |
| 3 | Error ellipse semi-major axis 1 sigma error, in meters |
| 4 | Error ellipse semi-minor axis 1 sigma error, in meters |
| 5 | Error ellipse orientation, degrees from true north |
| 6 | Latitude 1 sigma error, in meters |
| 7 | Longitude 1 sigma error, in meters |
| 8 | Height 1 sigma error, in meters |

GSV Satellite Information

The GSV message string identifies the number of SVs in view, the PRN numbers, elevations, azimuths, and SNR values. An example of the GSV message string is shown below. [Table A.5](#) describes the message fields.

```
$GPGSV,4,1,13,02,02,213,,03,-3,000,,
11,00,121,,14,13,172,05*67
```

Table A.5 GSV message fields

| Field | Meaning |
|-------|--------------------------------------------------------|
| 1 | Total number of messages of this type in this cycle |
| 2 | Message number |
| 3 | Total number of SVs visible |
| 4 | SV PRN number |
| 5 | Elevation, in degrees, 90° maximum |
| 6 | Azimuth, degrees from True North, 000° to 359° |
| 7 | SNR, 00–99 dB (null when not tracking) |
| 8–11 | Information about second SV, same format as fields 4–7 |
| 12–15 | Information about third SV, same format as fields 4–7 |
| 16–19 | Information about fourth SV, same format as fields 4–7 |

HDT Heading from True North

The HDT string is shown below, and [Table A.6](#) describes the message fields.

```
$GPHDT,123.456,T*00
```

Table A.6 Heading from true north fields

| Field | Meaning |
|-------|---------------------------------------------|
| 1 | Heading in degrees |
| 2 | T: Indicates heading relative to True North |

PTNL,GGK Time, Position, Position Type, DOP

An example of the PTNL,GGK message string is shown below. [Table A.7](#) describes the message fields.

```
$PTNL,GGK,172814.00,071296,  
3723.46587704,N,12202.26957864,W,  
3,06,1.7,EHT-6.777,M*48
```

Table A.7 PTNL,GGK message fields

| Field | Meaning |
|-------|-------------------------------------------------------------------------------------------------------------------------------------------------------------------------------------------------------------------------------------------------------------------------------------------------|
| 1 | UTC of position fix |
| 2 | Date |
| 3 | Latitude |
| 4 | Direction of latitude: N: North S: South |
| 5 | Longitude |
| 6 | Direction of Longitude: E: East W: West |
| 7 | GPS Quality indicator: 0: Fix not available or invalid 1: Autonomous GPS fix 2: Differential, floating carrier phase integer-based solution, RTK(float) 3: Differential, fixed carrier phase integer-based solution, RTK(fixed) 4: Differential, code phase only solution (DGPS) |
| 8 | Number of satellites in fix |
| 9 | DOP of fix |
| 10 | Ellipsoidal height of fix |
| 11 | M: ellipsoidal height is measured in meters |

Note – The PTNL,GGK message is longer than the NMEA-0183 standard of 80 characters.

PTNL,GGK_SYNC

Time, Synchronized Position, Position Type, DOP

The PTNL,GGK_SYNC message has the same format as the PTNL,GGK message, but outputs Synchronized 1 Hz positions even in Low Latency mode. An example of the PTNL,GGK_SYNC message string is shown below. [Table A.8](#) describes the message fields.

```
$PTNL,GGK_SYNC,172814.00,071296,
3723.46587704,N,12202.26957864,W,
3,06,1.7,EHT-6.777,M*48
```

Table A.8 PTNL,GGK_SYNC message fields

| Field | Meaning |
|-------|-------------------------------------------------------------------------------------------------------------------------------------------------------------------------------------------------------------------------------------------------------------------------------------------------|
| 1 | UTC of position fix |
| 2 | Date |
| 3 | Latitude |
| 4 | Direction of latitude: N: North S: South |
| 5 | Longitude |
| 6 | Direction of Longitude: E: East W: West |
| 7 | GPS Quality indicator: 0: Fix not available or invalid 1: Autonomous GPS fix 2: Differential, floating carrier phase integer-based solution, RTK(float) 3: Differential, fixed carrier phase integer-based solution, RTK(fixed) 4: Differential, code phase only solution (DGPS) |
| 8 | Number of satellites in fix |
| 9 | DOP of fix |
| 10 | Ellipsoidal height of fix |
| 11 | M: ellipsoidal height is measured in meters |

Note – The PTNL,GGK_SYNC message is longer than the NMEA-0183 standard of 80 characters.

PTNL,PJK Local Coordinate Position Output

An example of the PTNL,PJK message string is shown below. [Table A.9](#) describes the message fields.

```
$PTNL,PJK,010717.00,081796,  
+732646.511,N,+1731051.091,E,  
1,05,2.7,EHT-28.345,M*7C
```

Table A.9 PTNL,PJK message fields

| Field | Meaning |
|-------|---------------------------------------------------------------------------------------------------------------------------------------------------------------------------------------------------------------------------------------------------------------------------------------------|
| 1 | UTC of position fix |
| 2 | Date |
| 3 | Northing, in meters |
| 4 | Direction of Northing will always be N (North) |
| 5 | Easting, in meters |
| 6 | Direction of Easting will always be E (East) |
| 7 | GPS Quality indicator: 0: Fix not available or invalid 1: Autonomous GPS fix 2: Differential, floating carrier phase integer-based solution, RTK (float) 3: Differential, fixed carrier integer-based solution, RTK (fixed) 4: Differential, code phase only solution (DGPS) |
| 8 | Number of satellites in fix |
| 9 | DOP of fix |
| 10 | Ellipsoidal height of fix |
| 11 | M: ellipsoidal height is measured in meters |

Note – The PTNL,PJK message is longer than the NMEA-0183 standard of 80 characters.

PTNL,PJT Projection Type

An example of the PTNL,PJT message string is shown below. [Table A.10](#) describes the message fields.

```
$PTNL,PJT,NAD83(Conus),California Zone 4 0404,*51
```

Table A.10 PTNL,PJT message fields

| Field | Meaning |
|-------|-----------------------------------------------------|
| 1 | Coordinate system name (can include multiple words) |
| 2 | Projection name (can include multiple coordinates) |

PTNL,VGK

Vector Information

An example of the PTNL,VGK message string is shown below. [Table A.11](#) describes the message fields.

```
$PTNL,VGK,160159.00,010997,-0000.161,
00009.985,-0000.002,3,07,1,4,M*0B
```

Table A.11 PTNL,VGK message fields

| Field | Meaning |
|-------|-----------------------------------------------------------------------------------------------------------------------------------------------------------------------------------------------------------------------------------------|
| 1 | UTC of vector in hhmmss.ss format |
| 2 | Date in mmddyy format |
| 3 | East component of vector, in meters |
| 4 | North component of vector, in meters |
| 5 | Up component of vector, in meters |
| 6 | GPS quality indicator: 0: Fix not available or invalid 1: Autonomous GPS fix 2: Differential carrier phase solution RTK(float) 3: Differential carrier phase solution RTK(fix) 4: Differential code-based solution, DGPS |
| 7 | Number of satellites if fix solution |
| 8 | DOP of fix |
| 9 | M: Vector components are in meters |

PTNL,VHD

Heading Information

An example of the PTNL,VHD message string is shown below. [Table A.12](#) describes the message fields.

```
$PTNL,VHD,030556.00,093098,187.718,
-22.138,-76.929,-5.015,0.033,0.006,
3,07,2,4,M*22
```

Table A.12 PTNL,VHD message fields

| Field | Meaning |
|-------|----------------------------------------------------|
| 1 | UTC of position, in <i>hhmmss.ss,ddmmyy</i> format |
| 2 | Date in mmddyy format |
| 3 | Azimuth |
| 4 | Δ Azimuth/ Δ Time |
| 5 | Vertical Angle |
| 6 | Δ Vertical/ Δ Time |
| 7 | Range |
| 8 | Δ Range/ Δ Time |

Table A.12 PTNL,VHD message fields (continued)

| Field | Meaning |
|-------|-------------------------------------------------------------------------------------------------------------------------------------------------------------------------------------------------------------------------------------|
| 9 | Quality indicator: 0: Fix not available or invalid 1: Autonomous GPS fix 2: Differential carrier phase solution RTK(float) 3: Differential carrier phase solution RTK(fix) 4: Differential code-based solution, DGPS |
| 10 | Number of satellites used in solution |
| 11 | PDOP |

RMC **Position, Velocity, and Time**

The RMC string is shown below, and [Table A.13](#) describes the message fields.

```
$GPRMC,123519,A,4807.038,N,01131.000,E,022.4,084.4,230394,003.1,W*6A
```

Table A.13 GPRMC message fields

| Field | Meaning |
|-------|-----------------------------------------|
| 1 | UTC of position fix |
| 2 | Status A=active or V=void |
| 3 | Latitude |
| 4 | Longitude |
| 5 | Speed over the ground in knots |
| 6 | Track angle in degrees (True) |
| 7 | Date |
| 8 | Magnetic variation |
| 9 | The checksum data, always begins with * |

ROT **Rate of Turn**

The ROT string is shown below, and [Table A.14](#) describes the message fields.

```
$GPROT,35.6,A*4E
```

Table A.14 ROT message fields

| Field | Meaning |
|-------|----------------------------------------------------------------|
| 1 | Rate of turn, degrees/minutes, "-" indicates bow turns to port |
| 2 | A: Valid data V: Invalid data |

VTG Actual Track Made Good Over and Speed Over Ground

An example of the VTG message string is shown below. [Table A.15](#) describes the message fields.

```
$GPVTG,,T,,M,0.00,N,0.00,K*4E
```

Table A.15 VTG message fields

| Field | Meaning |
|-------|--------------------------------------------------|
| 1 | Track made good (degrees true) |
| 2 | T: track made good is relative to true north |
| 3 | Track made good (degrees magnetic) |
| 4 | M: track made good is relative to magnetic north |
| 5 | Speed, in knots |
| 6 | N: speed is measured in knots |
| 7 | Speed over ground in kilometers/hour (kph) |
| 8 | K: speed over ground is measured in kph |

ZDA UTC Day, Month, And Year, and Local Time Zone Offset

An example of the ZDA message string is shown below. [Table A.16](#) describes the message fields.

```
$GPZDA,172809,12,07,1996,00,00*45
```

Table A.16 ZDA message fields

| Field | Meaning |
|-------|----------------------------------------------------------------|
| 1 | UTC |
| 2 | Day, ranging between 01 and 31 |
| 3 | Month, ranging between 01 and 12 |
| 4 | Year |
| 5 | Local time zone offset from GMT, ranging from 00 to ±13 hours |
| 6 | Local time zone offset from GMT, ranging from 00 to 59 minutes |

Fields 5 and 6 together yield the total offset. For example, if field 5 is -5 and field 6 is +15, local time is 5 hours and 15 minutes earlier than GMT.

RTCM Output

In this appendix:

- [Generated messages](#)
- [Message scheduling](#)

Generated messages

Messages that are generated when you select a specific RTCM version are described below. These messages are in the same order as they appear in the GPS Configurator software. For the details of the contents of individual messages, refer to the RTCM documentation.

| Selection | Message | | | | | | | | |
|------------------|---------|---|-----|----|----|------|------|------|------|
| Version 2 | 1 | 3 | | | 22 | | | | 59 |
| USCG 9-3 | | 3 | 9-3 | | | | | | |
| RTCM/RTK 2.2+2.3 | 1 | 3 | | 18 | 19 | 22 | 23 | 24 | 59 |
| RTK Only 2.2+2.3 | | 3 | | 18 | 19 | 22 | 23 | 24 | 59 |
| RTCM/RTK 2.3 | 1 | | | 18 | 19 | | 23 | 24 | |
| RTK Only 2.3 | | | | 18 | 19 | 22 | | | |
| RTCM/RTK 2.2 | 1 | 3 | | 18 | 19 | 22 | | | 59 |
| RTK Only 2.2 | | 3 | | 18 | 19 | 22 | | | 59 |
| RTCM/RTK 2.1 | 1 | 3 | | 18 | 19 | 22 | | | 59 |
| RTK Only 2.1 | | 3 | | 18 | 19 | 22 | | | 59 |
| RTCM/RTK 3.00 | | | | | | 1004 | 1006 | 1008 | 1013 |

Message scheduling

The frequency at which messages are generated when they are enabled in a base receiver is described below.

| Type | Frequency |
|------------|-------------------------------------------------------------------------------|
| 1 | Every second |
| 3 | The 10th second after the first measurement, then every 10 seconds after that |
| 9-3 | Every second |
| 18 | Every second |
| 19 | Every second |
| 22 | The 5th second after the first measurement, then every 10 seconds after that |
| 23 | The 4th second after the first measurement, then every 10 seconds after that |
| 24 | The 4th second after the first measurement, then every 10 seconds after that |
| 59-sub, 13 | The 5th second after the first measurement, then every 10 seconds after that |
| 1004 | Every second |
| 1006 | Every 10 seconds |
| 1008 | Every 10 seconds |
| 1013 | Every 300 seconds |

Troubleshooting

In this appendix:

- [LED conditions](#)
- [Receiver issues](#)

LED conditions

An LED that is flashing quickly indicates a condition that may require attention, and an unlit LED indicates that no operation is occurring. The following table describes some LED conditions, possible causes, and how to solve them.

| Condition | Possible cause | Solution |
|-----------------------------------------------------------------------------------|--------------------------------------------------------------------------------------------------|--------------------------------------------------------------------------------------------------------------------------------------------------------------------------------|
| The SV Tracking LED is lit solidly and the Logging/memory LED is flashing slowly. | The receiver is in Monitor mode, ready for new firmware to be loaded or new options to be added. | Turn off or turn on the receiver. Load the latest version of the firmware, which you can download from www.trimble.com/support |
| The SV Tracking LED is flashing rapidly. | The receiver is tracking fewer than four satellites. | Wait until the SV Tracking LED is flashing slowly. |
| The SV Tracking LED is not flashing | The radio antenna cable and GPS antenna cable are mixed up. | Make sure that the GPS antenna cable (with the yellow over-mould) is connected between the yellow TNC connector marked GPS and the GPS antenna. |

Receiver issues

The following table describes some possible receiver issues, possible causes, and how to solve them.

| Issue | Possible cause | Solution |
|-----------------------------------------|-------------------------------------------------------------------|---------------------------------------------------------------------------------------------------------------------------------------------------------------------------------------------------------------------------------------------------------------------------|
| The receiver does not turn on. | External power too low. | Check the charge on the external battery, and check the fuse if applicable. Replace the battery if necessary. |
| | Internal power too low. | Check the charge on the internal batteries and replace if necessary. Ensure battery contacts are clean. |
| | External power not properly connected. | Check that the Lemo connection is seated properly. Check for broken or bent pins in the connector. |
| | Faulty power cable. | Try a different cable. Check pinouts with multimeter to ensure internal wiring is intact. |
| Receiver does not log data. | Insufficient internal memory. | Delete old files using the GPS Configurator or Trimble Survey Controller software, or by holding down the Power button for 30 seconds. |
| | The receiver is tracking fewer than four satellites. | Wait until the SV Tracking LED is flashing slowly. |
| The receiver is not responding. | Receiver needs soft reset. | Power down the receiver and power back up. |
| | Receiver needs full reset. | Hold down  for 30 seconds. If you want to retain data files, remove the CompactFlash card first. |
| Reference receiver is not broadcasting. | Port settings between reference receiver and radio are incorrect. | Using the Trimble Survey Controller software, connect to the reference radio through the receiver. If no connection is made, connect directly to the radio and change the port settings. Try to connect through the receiver again to ensure that they are communicating. |
| | Faulty cable between receiver and radio. | Try a different cable. Examine the ports for missing pins. Use a multimeter to check pinouts. |
| | No power to radio. | If the radio has its own power supply, check the charge and connections. |

| Issue | Possible cause | Solution |
|-----------------------------------------|---------------------------------------------------------------------|-------------------------------------------------------------------------------------------------------------------------------------------------------------------------------------------------------|
| Roving receiver is not receiving radio. | Reference receiver is not broadcasting. | See above. |
| | Incorrect over air baud rates between reference and rover. | Connect to the roving receiver's radio and check to ensure it has the same setting as the reference receiver. |
| | Incorrect port settings between roving external radio and receiver. | If the radio is receiving data (the Logging/memory LED is flashing) and the receiver is not getting radio communications, use Trimble Survey Controller to check that the port settings are correct. |
| | The cellular modem does not have hardware flow control enabled. | Disable flow control on the modem. Use a special cable. For more information, refer to the document <i>Using Cellular and CDPD Modems for RTK</i> , which is available from your Trimble reseller. |

Software Utilities

In this chapter:

- [The GPS Configurator software](#)
- [The WinFlash utility](#)

This chapter describes the software utilities that you can use with the receiver.

The GPS Configurator software

GPS Configurator is office software that configures selected Trimble receivers.

This software enables you to:

- edit and save configuration files to the receiver and the computer
- check current receiver settings and operation
- change receiver settings in real time

Installing the GPS Configurator software

A copy of the GPS Configurator software is included on the receiver CD.

1. Insert the disk into the CD drive on your office computer.
2. From the main menu, select *Install individual software packages*.
3. Select *Install GPS Configurator vX.XX*.
4. Follow the on-screen instructions.

Configuring the receiver using the GPS Configurator software

1. Connect Port 1 or 2 on the receiver to a serial (COM) port on the computer and then apply power.
2. To start the GPS Configurator software, click  and then select *Programs / Trimble / GPS Configurator / GPS Configurator*.
3. In the *Device Type* dialog, select **XXXXX**.
The software automatically establishes a connection with the receiver.
4. Make appropriate selections for your required receiver settings.
For more information, refer to the *GPS Configurator Help*.
5. Click **Apply**.

The settings in the GPS Configurator software are applied to the receiver.

The WinFlash utility

The WinFlash utility communicates with Trimble products to perform various functions including:

- installing software, firmware, and option upgrades
- running diagnostics (for example, retrieving configuration information)
- configuring radios

For more information, online help is also available when using the WinFlash utility.

Note – *The WinFlash utility runs on Windows 2000, XP, or Windows Vista[®] operating systems.*

Installing the WinFlash utility

Install the WinFlash utility from the receiver CD:

1. Insert the disk into the CD drive on your computer.
2. From the main menu, select *Install individual software packages*.
3. Select *Install WinFlash vX.XX with Trimble R5 drivers and firmware* and then follow the on-screen instructions.

Alternatively, install the WinFlash utility from the Trimble website.

Upgrading firmware

Your receiver is supplied with the latest version of receiver firmware installed. If a later version becomes available, upgrade the firmware installed on your receiver.

The WinFlash utility guides you through the firmware upgrade process, as described below. For more information, refer to the *WinFlash Help*.

To upgrade the receiver firmware:

1. Start the WinFlash utility. The *Device Configuration* screen appears.
2. From the *Device type* list, select *R5* or *Trimble R7*.
3. From the *PC serial port* field, select the serial (COM) port on the computer that the receiver is connected to.
4. Click **Next**.

The *Operation Selection* screen appears. The *Operations* list shows all of the supported operations for the selected device. A description of the selected operation is shown in the *Description* field.

5. Select *GPS software upgrade* and then click **Next**.

The *GPS Software Selection* dialog appears. This screen prompts you to select the software that you want to install on the receiver.

6. Select the latest version from the *Available Software* list and then click **Next**.

The *Settings Review* dialog appears. This screen prompts you to connect the receiver, suggests a connection method and then lists the receiver configuration and selected operation.

7. If all is correct, click **Finish**.

Based on your selections, the *Software Upgrade* window appears and shows the status of the operation (for example, **Establishing communication with the R7 GNSS. Please wait.**).

8. Click **OK**.

The *Software Upgrade* window appears again and states that the operation was completed successfully.

9. Click **Menu** to select another operation, or click **Exit** to quit WinFlash.

10. If you click **Exit**, another screen appears asking you to confirm that you want to quit. Click **OK**.

Adding frequencies for the 450 MHz internal radio

If your receiver has the optional internal radio installed, you can use the WinFlash utility to add receiving frequencies to the default list:

1. Start the WinFlash utility. The *Device Configuration* dialog appears.
2. From the *Device type* list, select the appropriate receiver name.
3. From the *PC serial port* field, select the serial (COM) port on the computer that the receiver is connected to.
4. Click **Next**.

The *Operation Selection* screen appears. The *Operations* list shows all of the supported operations for the selected device. A description of the selected operation is shown in the *Description* field.

5. Select Configure Radio and then click **Next**.

The *Frequency Selection* dialog appears:

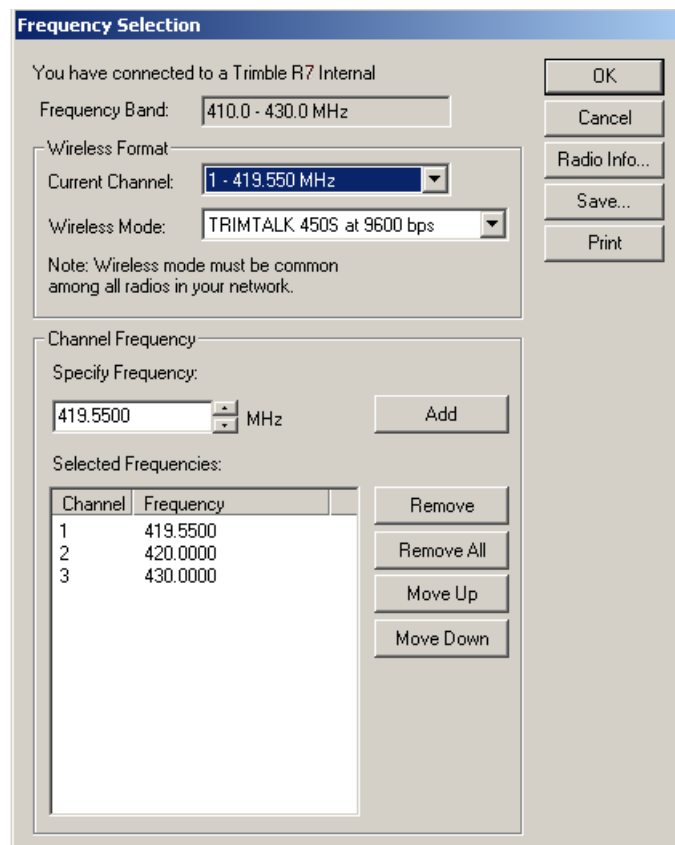

6. In the *Wireless Format* group, select the appropriate channel and wireless mode. The *Wireless Mode* must be the same for all radios in your network.
7. In the *Specify Frequency* field, enter the frequency you require.
8. Click **Add**. The new frequency appears in the *Selected Frequencies* list.

Note – *The frequencies that you program must conform to the channel spacing and minimum tuning requirements for the radio. To view this information, click **Radio Info**. You may select either 12.5 or 25 kHz channel spacing. All radios in your network must use the same channel spacing.*

9. When you configure all the frequencies you require, click **OK**. The WinFlash utility updates the receiver radio frequencies and then restarts the receiver.

Blank page: Inside cover



NORTH AMERICA

Trimble Engineering &
Construction Group
5475 Kellenburger Road
Dayton, Ohio 45424-1099 • USA
800-538-7800 (Toll Free)
+1-937-245-5154 Phone
+1-937-233-9441 Fax

EUROPE

Trimble GmbH
Am Prime Parc 11
65479 Raunheim • GERMANY
+49-6142-2100-0 Phone
+49-6142-2100-550 Fax

ASIA-PACIFIC

Trimble Navigation
Singapore Pty Limited
80 Marine Parade Road
#22-06, Parkway Parade
Singapore 449269 • SINGAPORE
+65-6348-2212 Phone
+65-6348-2232 Fax



www.trimble.com